



5600SE Valve

Carbon & Multi-Media Filter Operation Manual

Performance and Specifications

Hydrotech Taste & Odor Filter (Carbon)

Item Number	Model Number	Media cu. ft. (litres)	Pipe Size inches (mm)	Service Flow Rate	Peak Flow Rate	Backwash Flow Rate	Mineral Tank size inches (mm)	Shipping Weight Lbs. (kg)
7615	5600SEM-847AC	0.75 (21)	3/4 (19)	4.0 (15)	5.0 (19)	3.5 (13)	8 x 47 (203 x 1194)	45 (20)
7616	5600SEM-948AC	1.00 (28)	3/4 (19)	4.0 (15)	6.0 (23)	4.0 (15)	9 x 48 (229 x 1219)	60 (27)
7617	5600SEM-1054AC	1.50 (42)	3/4 (19)	5.0 (19)	7.0 (27)	5.0 (19)	10 x 54 (254 x 1372)	78 (35)

Hydrotech Turbidity Filter (Multi-Media)

Item Number	Model Number	Media cu. ft. (litres)	Pipe Size inches (mm)	Service Flow Rate	Peak Flow Rate	Backwash Flow Rate	Mineral Tank size inches (mm)	Shipping Weight Lbs. (kg)
7618	5600SEM-847MM	0.75 (21)	3/4 (19)	4.0 (15)	5.0 (19)	4.0 (15)	8 x 47 (203 x 1194)	95 (43)
7619	5600SEM-948MM	1.00 (28)	3/4 (19)	5.0 (19)	7.0 (38)	5.0 (19)	9 x 48 (229 x 1219)	145 (66)
7620	5600SEM-1054MM	1.50 (42)	3/4 (19)	7.0 (38)	10.0 (38)	7.0 (38)	10 x 54 (254 x 1372)	213 (97)

Caution: These water conditioners are not intended to be used for treating water that is microbiologically unsafe or of unknown quality without adequate disinfection before or after the system.

Notes:

Operating Temperature Range: 34° to 110°F (1° to 43°C)

Operating Pressure Range: 20 to 120psi (137 to 827 kPa)



Electrical: 24V/60Hz with a supplied 120V/60Hz Wall Mount CSA Approved Transformer

1. The manufacturer reserves the right to make product improvements which deviate from the specifications and descriptions stated herein without obligation to change previously manufactured products or to note the change.
2. Peak flow rates are intended for intermittent use only and are for residential application only.

How Your 5600 SE Water Filter Works

Raw water enters your home through the main supply line, enters your filter, and passes downward through the media bed. Impurities such as turbidity and sediment (multi-media filter) and organics and chlorine (taste and odor filter) are removed from the water. The filtered water then flows into your household water lines. Periodic regeneration is required to flush entrapped material from the system.

In normal operation, the Time of Day display will alternate being viewed with the Volume Remaining display. This display will be in gallons. As treated water is used, the Volume Remaining display will count down from a maximum value to zero or (---). Once this occurs, a regeneration cycle will be initiated at the Set Regeneration Time. Water flow through the valve is indicated by the Flow Dot that will flash in direct relationship to flow rate.

Example	833 Gallons of Treated Water Remaining	Service		Flow
		Program		P.M.
	0 Gallons of Treated Water Remaining	Service		Flow
		Program		P.M.

In regeneration, the control will display a special regeneration display. In this display, the control will show the current regeneration step number the valve is advancing to or has reached and the time remaining in that step. The step number displayed will flash until the valve has completed driving into this regeneration step position. Once all regeneration steps have been completed, the valve will return to Service and resume normal operation.

Example	Less than 6 minutes remaining in Regen Step #1	Service		Flow
		Program		P.M.

Pushing the *extra cycle* button during a regeneration cycle will immediately advance the valve to the next cycle step position and resume normal step timing.

Control Operation During Programming

The control will only enter the Program Mode with the valve in Service. While in the Program Mode, the control will continue to operate normally, monitoring water usage and keeping all displays up to date. Control programming is stored in memory permanently, eliminating the need for battery back-up power.

Control Operation During a Power Failure

During a power failure, all control displays and programming will be stored for use upon power re-application. *The control will retain these values for years, if necessary, without loss.* The control will be fully inoperative and any calls for regeneration will be delayed. The control will, upon power re-application, resume normal operation from the point where it was interrupted. *An indication that a power outage has occurred will be an inaccurate Time of Day display.*

Installation Instructions

All government codes and regulations governing the installation of these devices must be observed.

CAUTION: If the ground from the electrical panel or breaker box to the water meter or underground copper pipe is tied to the copper water lines and these lines are cut during installation of the Noryl bypass valve and/or poly pipe, an approved grounding strap must be used between the two lines that have been cut in order to maintain continuity. The length of the grounding strap will depend upon the number of units being installed and/or the amount of copper pipe being replaced with poly. See Figure 1.

In all cases where metal pipe was originally used and is later interrupted by poly pipe or the Noryl bypass valve as in Figure 1 or by physical separation as in Figure 2, an approved ground clamp with no less than #6 copper conductor must be used for continuity, to maintain proper metallic pipe bonding.

Check your local electrical code for the correct clamp and cable size.

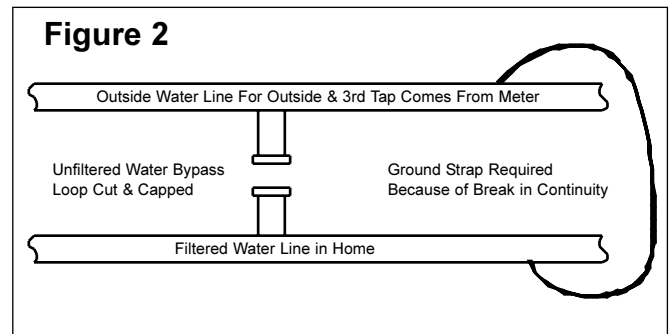
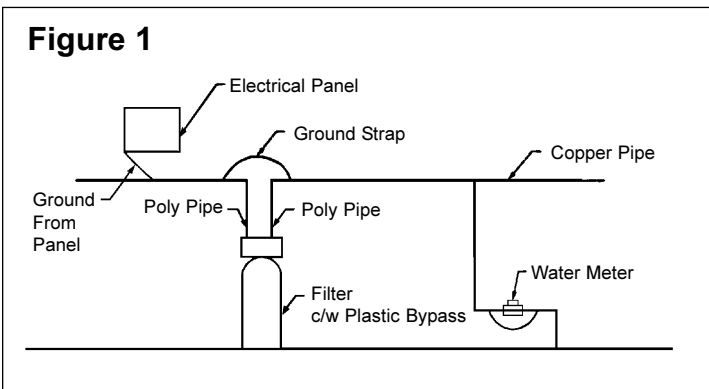

1. Determine the best location for your water filter, bearing in mind the location of your water supply lines, drain line and 120 volt AC electrical outlet. Subjecting the softener to freezing or temperatures above 110°F (43° C) will void the warranty.

NOTE: Some units are shipped with the media bed in separate bags. To install, unscrew the control valve from the top of the fiberglass tank, position the riser tube in the center of the tank lugging the tube with a cloth and pour the media into the tank in the following order: coarse, fine gravel and then the filter media. Remove the cloth and carefully screw the valve into the tank (When replacing the media, the tank must first be inverted and the old media bed removed. See instructions provided with the replacement media).

Municipal or Urban Supply - Taste & Odor and Hardness Removal

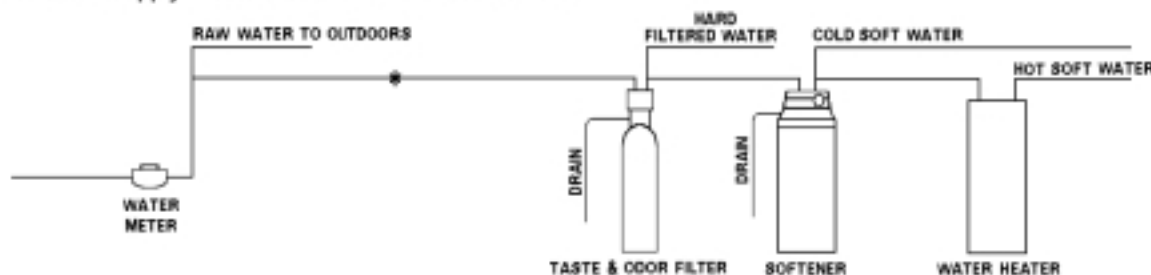

Rural Surface Supply - Bacteria, Extreme Iron, Sediment, Taste & Odor, Hardness Removal

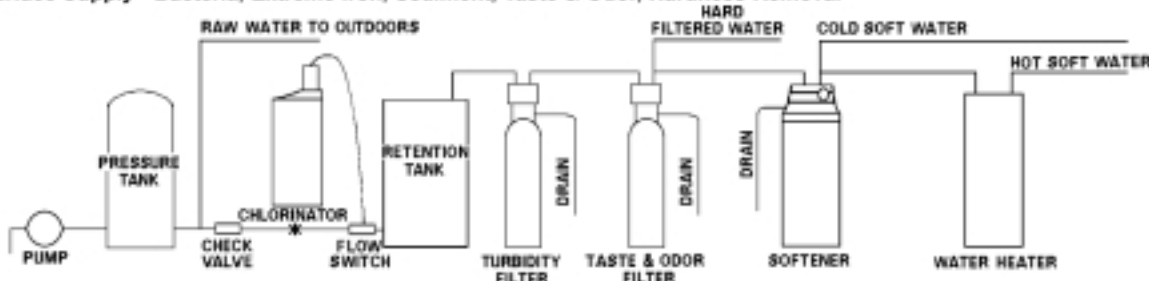

2. Attach the bypass valve to the control valve. Connect the inlet and outlet of the water filter to the plumbing in the house. The control valve must not be submitted to temperatures above 71°C (110°F). When sweat fittings are used, to avoid damaging the control valve, solder the threaded copper adapters to the copper pipe and then, using Teflon tape, screw the assembly onto the bypass valve.
CAUTION: Do not use pipe thread compound as it may attack the material in the valve body.
3. Using teflon tape, screw the 1/2" hose barb into the drain port in the valve. Attach 1/2" drain hose to the hose barb and tighten securely with a hose clamp. Run the drain line to a floor drain or a laundry drain. Complete any necessary plumbing.
4. Make sure the bypass valve is in the service position.
5. Plug the 24-volt transformer into a 120 VAC 60 Hz outlet. This valve has four positions: 1) Backwash 2) Brine/Rinse (not used) 3) Rapid Rinse and 4) Brine Refill (not used). When the valve is in the Service position, the *extra cycle* button (far left button as shown on Figure 4) must be pressed and held for 5 seconds before it activates. Press and hold the *extra cycle* button for 5 seconds to advance the valve to the "1" Backwash position. Slowly turn on the water supply and allow the unit to backwash until the air purges out of the tank and clears the system.
NOTE: On taste and odor filters, the initial water running to the drain will be very black. This is created by the carbon fines being flushed from the bed. Backwash all filters until the water running to the drain is clear.
6. Press the *extra cycle* button to advance the valve to the "2" position (not used). Press once more to advance to the "3" position. Press once more to advance to the "4" Brine refill position. Press the *extra cycle* button to advance the valve back into the service position indicated by the red dot in the upper left corner of the display.

Operating Instructions

Service Indicator:
Valve in Service - Dot On
Extra Cycle Tonight - Flashing Dot

Flow Indicator:
Flashing Dot With Water Flow
P.M. Indicator

Set Up Button
Set Down Button

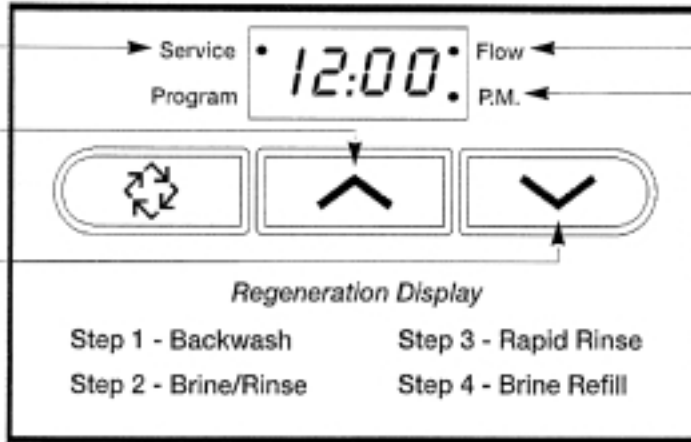

Figure 4

The Valve has been pre-programmed with factory settings as follows:

Regeneration Step

1. Backwash
2. Brine/Rinse
3. Rapid Rinse
4. Brine Refill

Cycle Programming

- 6 minutes
- 0 minutes - not applicable
- 4 minutes
- 0 minutes - not applicable

Operating Instructions

Whenever the valve is in Service the current time of day can be set, the control programmed, or an extra regeneration initiated at any time.

1. Set Time Of Day

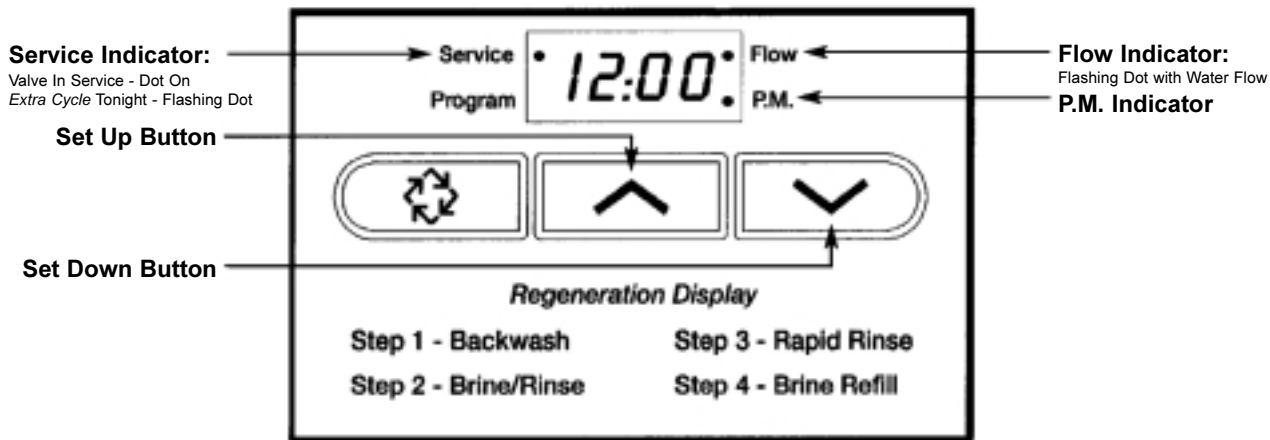

Push either the Up or Down Set Button once to adjust Time of Day Display by one digit.
Push and hold either Up or Down Set Button to adjust Time of Day Display by several digits.

2. Enter Control Programming Mode

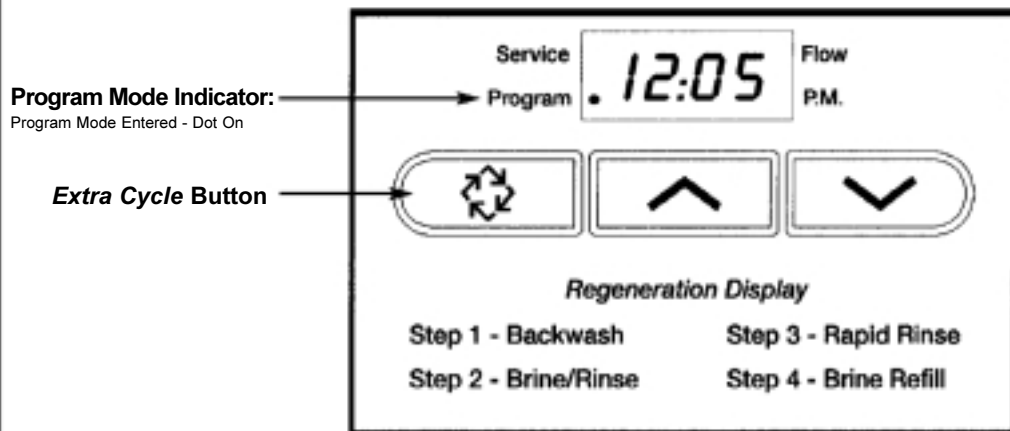

1. Push and hold for 5 seconds *both* the Up and Down Set Buttons to enter Programming Mode.
2. Push the *Extra Cycle Button* once per display until all have been viewed and this mode is exited and normal operation is resumed.

3. Set Control Programming

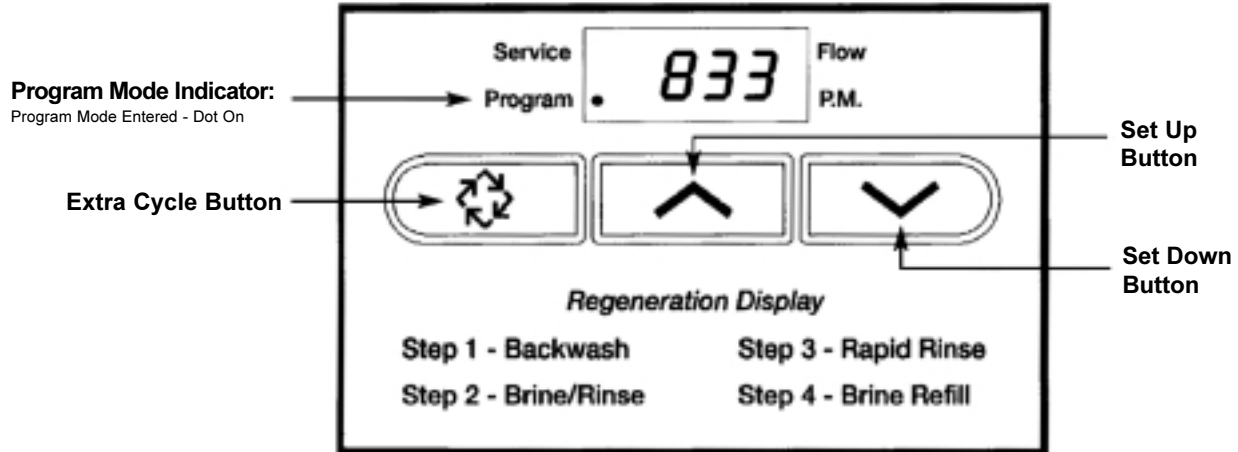

1. The first option setting display that appears in the Program Mode is Treated Water Capacity. Using the Set Up or Down Buttons, set the amount of treated water that can flow through the unit before a regeneration is required. For Example:

650 Gallons Capacity Service Flow
 Program . 650 P.M.

2. Push the Extra Cycle Button. The second option setting display that appears is Regeneration Time. Using the Set Up or Down Buttons, set the desired time of day when a regeneration can occur, is required. For Example:

2:00 A.M. Regeneration Time Service Flow
 Program . 2:00 P.M.

3. Push the Extra Cycle Button. The third option setting display that appears is Regeneration Day Override. Using the Set Up or Down Buttons, set the maximum number of days before a regeneration cycle must occur. For Example:

Regenerate Every
 7 Days Minimum Service Flow
 Program . A - - 7 P.M.

This is an option only. Please do not adjust before consulting an authorized dealer.

Operating Instructions

Water Pressure

Your water filter is designed to operate under normal water pressures from 20 psi to 100 psi.

Regeneration and Automatic Bypass

Water filters are factory set to regenerate at 11:00 p.m. during a period of little or no water use. The regeneration cycle lasts approximately 15 minutes, after which filtered water service is restored. While regeneration is taking place, "raw water" automatically bypasses the filter if required. If possible, avoid using water during regeneration to prevent unfiltered water entering your household plumbing system.

(Installation Tip: The 5600SE Filter should not be allowed to regenerate at the same time as any other water treatment units. If adjustment is required, consult programming chart to adjust default regeneration time.)

New Sounds

You will notice new sounds such as the hum of the timer, as your filter operates. During regeneration, it will not be uncommon to hear water running to the drain.

Manual Bypass

In case of an emergency you can isolate your water filter from the water supply using the bypass valve located at the back of the control.

In normal operation the bypass is open with the ON/OFF knobs in line with the INLET and OUTLET pipes. To isolate the filter, simply rotate the knobs clockwise (as indicated by the word BYPASS and arrow) until they lock.

You can use your water related fixtures and appliances as the water supply is bypassing the filter. However, the water you use will be untreated.

To resume filter water service, open the bypass valve by rotating the knobs counter-clockwise.

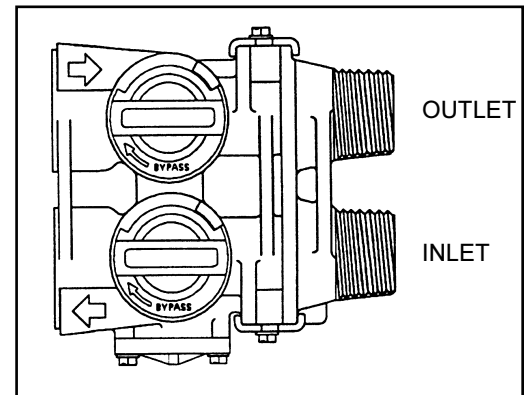

Manual Regeneration Cycle

If you run out of filtered water because of inadequate regeneration frequency, inadequate reserve capacity, power failure or unusually high water usage, you can initiate a manual regeneration simply by pressing the extra cycle button. The filter will now automatically complete a regeneration cycle and return to service. If possible, avoid water use during the regeneration cycle.

Once you have set your filter and you experience frequent loss of water pressure, you may have to increase the frequency of regeneration by resetting the gallons between regeneration.

Maintenance Instructions

Maintenance of your new water filter requires very little time or effort but it is essential. Regular maintenance will ensure many years of efficient and trouble free operation.

Care of all Water Filters

To retain the attractive appearance of your new water filter, clean occasionally with a mild soap solution. DO NOT use abrasive cleaners, ammonia or solvents. Never subject your filter to freezing.

Replacing Media Bed

Taste and Odor Filter (Carbon)

Under normal operating conditions the effective life of the filter media is approximately three (3) years, after which, taste and odor problems may return. When this occurs, contact your dealer for a replacement media bed.

Turbidity Filter (Multi-Media)

Under normal operating conditions the media should never need to be replaced. If you experience pressure loss and cannot correct it with a manual regeneration, your media bed may need replacing - contact your dealer.

Trouble Shooting Guide

PROBLEM	CAUSE	CORRECTION
1. Filter bleeds taste and odor or sediment	<ul style="list-style-type: none"> A. Bypass valve is open B. Electrical service to unit has been interrupted C. Defective or stripped media bed D. Quality of water has worsened any change E. Filter capacity too small F. Filter not backwashing enough G. Excessive water usage - calendar clock models 	<ul style="list-style-type: none"> A. Close bypass valve B. Assure permanent electrical service (check fuse, plug or switch) C. Replace media D. Have water sample analyzed to determine E. Replace with larger unit or add another filter F. Be sure flow control is not clogged or drain line restricted. Be sure water pressure has not dropped and that pump has sufficient capacity G. Increase frequency of regeneration. Make sure there are no leaks in toilets or sinks
2. Filter fails to regenerate	<ul style="list-style-type: none"> A. Electrical service to unit has been interrupted B. Timer is defective C. Power failure D. Timer motor does not run 	<ul style="list-style-type: none"> A. Assure permanent electrical service (check fuse, plug or switch) B. Replace timer C. Reset time of day D. Replace defective motor
3. Filter regenerates every day	<ul style="list-style-type: none"> A. Faulty gear train 	<ul style="list-style-type: none"> A. Check the mechanical linkage on the timer control to eliminate possible binding in the gear train
4. Loss of water pressure	<ul style="list-style-type: none"> A. Iron or turbidity build-up in filter B. Filter not regenerating often enough C. Not enough water volume or pressure to backwash properly 	<ul style="list-style-type: none"> A. Clean control and treat bed with Iron Out. Increase frequency of regeneration B. Increase frequency of regeneration C. Correct water supply problem
5. Loss of media through drain line	<ul style="list-style-type: none"> A. Air in water system B. Backwash rate too fast 	<ul style="list-style-type: none"> A. Assure that well system has proper air eliminator control. Check for dry well condition B. Check drain flow control for proper flow rates
6. Drain flows continuously	<ul style="list-style-type: none"> A. Foreign material in control B. Timer motor stopped or jammed 	<ul style="list-style-type: none"> A. Remove piston assembly and inspect bore. Remove foreign material and check control in various regeneration positions B. Replace timer motor

GUARANTEE

HYDROTECH guarantees that your new water conditioner is built of quality material and workmanship. When properly installed and maintained, it will give years of trouble-free service.

FIVE YEAR COMPLETE PARTS GUARANTEE

HYDROTECH will replace any part which fails within 60 months from date of manufacture, provided the failure is due to a defect in material or workmanship. The only exception shall be when proof of purchase or installation is provided and then the warranty period shall be from the date thereof.

TEN YEAR GUARANTEE ON MINERAL TANKS

HYDROTECH will provide a replacement mineral tank to any original equipment purchaser in possession of a tank that fails within 120 months, provided that the water conditioner is at all times operated in accordance with specifications and not subject to freezing or exposure to direct sunlight.

GENERAL PROVISIONS

HYDROTECH assumes no responsibility for consequential damage as a result of escaped water from the water filter; labor or expense incurred as a result of a defect or for failure to meet the terms of these guarantees because of circumstances beyond its control.

WaterGroup Inc.
Fridley, Minnesota
Sun Valley, California
1-800-354-7867

WaterGroup Companies Inc.
Regina, Saskatchewan
Cambridge, Ontario
1-877-299-5999

www.hydrotechwater.com

Printed in Canada