



7000SXT Valve

nextSand Turbidity & Sediment Filter Operation Manual

Performance and Specifications

Model #	Flow Rates USGPM (For ultrafine particle removal)			Flow rates for Typical Application USGPM			Installation Space	Fiberglass Tank Size - Inches	Shipping Weight - Lbs
	Service	Peak	Backwash	Service	Peak	Backwash			
7000CC-847NEXTSF-75	4.0	5.0	5	5.6	7.0	5	10 x 21 x 57	8 X 47	95
7000CC-948NEXTSF-100	5.0	7.0	7	7.1	8.8	7	11 x 21 x 58	9 X 48	145
7000CC-1054NEXTSF-150	7.0	8.0	8	8.7	10.9	8	12 x 21 x 64	10 X 54	213
7000CC-1252NEXTSF-200	10.0	12.0	12	12.6	15.7	12	14 x 21 x 62	12 X 52	265

Caution: These water conditioners are not intended to be used for treating water that is microbiologically unsafe or of unknown quality without adequate disinfection before or after the system.

- Notes:**
- Operating Temperature Range:** 34° to 110°F (1° to 43°C)
 - Operating Pressure Range:** 20 to 120psi (137 to 827 kPa)
 - Electrical:** 24V/60Hz with a supplied 120V/60Hz Wall Mount Approved Transformer
- The manufacturer reserves the right to make product improvements which deviate from the specifications and descriptions stated herein without obligation to change previously manufactured products or to note the change.
 - Peak flow rates are intended for intermittent use only and are for residential application only.

How Your 7000SXT Water Filter Works

Raw water enters your home through the main supply line, enters your filter, and passes downward through the media bed. Impurities such as turbidity and sediment (nextSand filter) are removed from the water. The filtered water then flows into your household water lines. Periodic regeneration is required to flush entrapped material from the system.

In normal operation, the Time of Day display will alternate being viewed with the Volume Remaining display. This display will be in gallons, liters or cubic meters. As treated water is used, the Volume Remaining display will count down from a maximum value to zero or (---). Once this occurs, a regeneration cycle will be initiated at the Set Regeneration Time. Water flow through the valve is indicated by the Flow Indicator that will flash in direct relationship to flow rate.

Example 833 Gallons of Treated Water Remaining

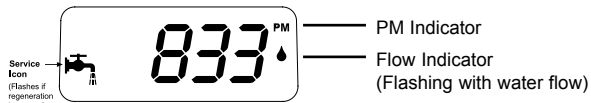

0 Gallons of Treated Water Remaining

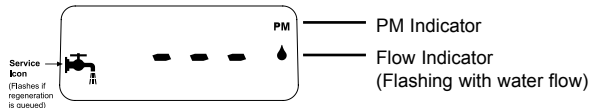

Control Operation During Regeneration

In regeneration, the control will display a special regeneration display. In this display, the control will show the current regeneration step number the valve is advancing to or has reached and the time remaining in that step. The step number displayed will flash until the valve has completed driving into this regeneration step position. Once all regeneration steps have been completed, the valve will return to Service and resume normal operation.

Example Less than 6 minutes remaining in Regen Step Rapid Rinse

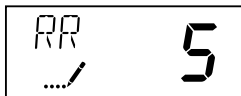

Pushing the Extra Cycle Button during a regeneration cycle will immediately advance the valve to the next cycle step position and resume normal step timing.

Control Operation During Programming

The control will only enter the Program Mode with the valve in Service. While in the Program Mode, the control will continue to operate normally, monitoring water usage and keeping all displays up to date. Control programming is stored in memory permanently, eliminating the need for battery back-up power.

Meter Immediate Control

A meter immediate control measures water usage and regenerates the system as soon as the calculated system capacity is depleted. The control calculates the system capacity by dividing the unit capacity (typically expressed in grains/unit volume) by the feed water hardness and subtracting the reserve. Meter Immediate systems generally do not use a reserve volume. However, in twin tank systems with soft-water regeneration, the reserve capacity should be set to the volume of water used during regeneration to prevent hard water break-through. A Meter Immediate control will also start a regeneration cycle at the programmed regeneration time if a number of days equal to the regeneration day override pass before water usage depletes the calculated system capacity.

Meter Delayed Control

A Meter Delayed Control measures water usage and regenerates the system at the programmed regeneration time after the calculated system capacity is depleted. As with Meter Immediate systems, the control calculates the system capacity by dividing the unit capacity by the feed water hardness and subtracting the reserve. The reserve should be set to insure that the system delivers treated water between the time the system capacity is depleted and the actual regeneration time. A Meter Delayed control will also start a regeneration cycle at the programmed regeneration time if a number of days equal to the regeneration day override pass before water usage depletes the calculated system capacity.

Time Clock Delayed Control

A Time Clock Delayed Control regenerates the system on a timed interval. The control will initiate a regeneration cycle at the programmed regeneration time when the number of days since the last regeneration equals the regeneration day override value.

Day of the Week Control

This control regenerates the system on a weekly schedule. The schedule is defined in Master Programming by setting each day to either "off" or "on." The control will initiate a regeneration cycle on days that have been set to "on" at the specified regeneration time.

Control Operation During a Power Failure

The SXT includes integral power backup. In the event of power failure, the control shifts into a power-saving mode. The control stops monitoring water usage, and the display and motor shut down, but it continues to keep track of the time and day for a minimum of 48 hours.

The system configuration settings are stored in a non-volatile memory and are stored indefinitely with or without line power. The Time of Day flashes when there has been a power failure. Press any button to stop the Time of Day from flashing.

If power fails while the unit is in regeneration, the control will save the current valve position before it shuts down. When power is restored, the control will resume the regeneration cycle from the point where power failed. Note that if power fails during a regeneration cycle, the valve will remain in its current position until power is restored. The valve system should include all required safety components to prevent overflows resulting from a power failure during regeneration.

The control will not start a new regeneration cycle without line power. If the valve misses a scheduled regeneration due to a power failure, it will queue a regeneration. Once power is restored, the control will initiate a regeneration cycle the next time that the Time of Day equals the programmed regeneration time. Typically, this means that the valve will regenerate one day after it was originally scheduled. If the treated water output is important and power interruptions are expected, the system should be setup with a sufficient reserve capacity to compensate for regeneration delays.

Installation Instructions

All government codes and regulations governing the installation of these devices must be observed.

CAUTION: If the ground from the electrical panel or breaker box to the water meter or underground copper pipe is tied to the copper water lines and these lines are cut during installation of the Noryl bypass valve and/or poly pipe, an approved grounding strap must be used between the two lines that have been cut in order to maintain continuity. The length of the grounding strap will depend upon the number of units being installed and/or the amount of copper pipe being replaced with poly. See Figure 1.

In all cases where metal pipe was originally used and is later interrupted by poly pipe or the Noryl bypass valve as in Figure 1 or by physical separation as in Figure 2, an approved ground clamp with no less than #6 copper conductor must be used for continuity, to maintain proper metallic pipe bonding.

Check your local electrical code for the correct clamp and cable size.

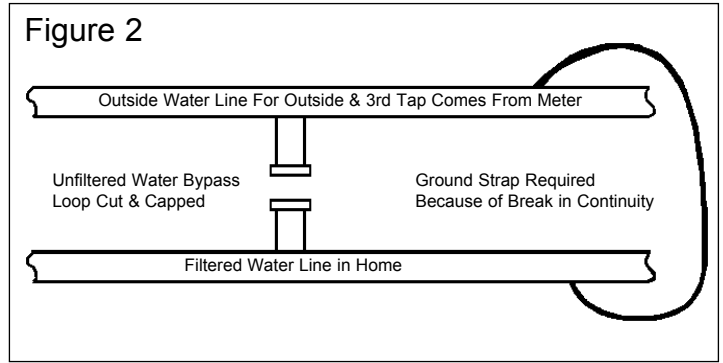
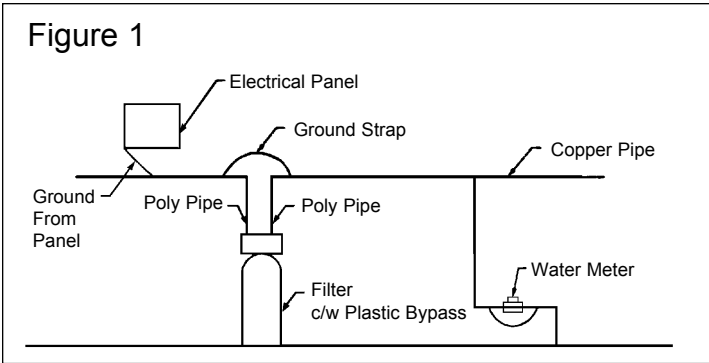

- Determine the best location for your water filter, bearing in mind the location of your water supply lines, drain line and 120 volt AC electrical outlet. Subjecting the softener to freezing or temperatures above 110°F (43° C) will void the warranty.

NOTE: Some units are shipped with the media bed in separate bags. To install, unscrew the control valve from the top of the fiberglass tank, position the riser tube in the center of the tank lugging the tube with a cloth and pour the media into the tank in the following order: coarse, fine gravel and then the filter media. Remove the cloth and carefully screw the valve into the tank (When replacing the media, the tank must first be inverted and the old media bed removed. See instructions provided with the replacement media).

Municipal or Urban Supply - Taste & Odor and Hardness Removal

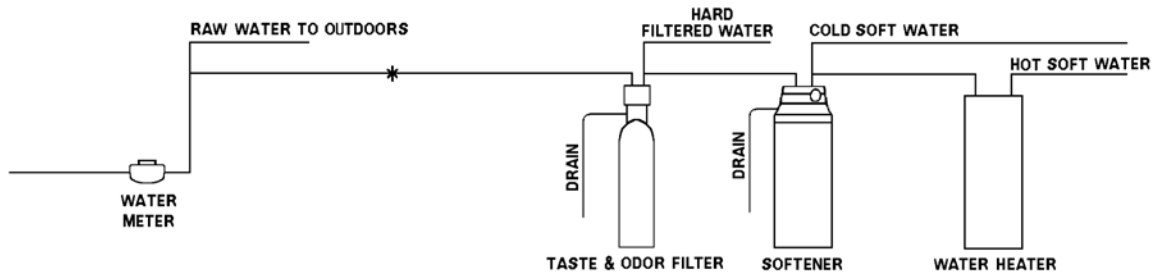

Rural Surface Supply - Bacteria, Extreme Iron, Sediment, Taste & Odor, Hardness Removal

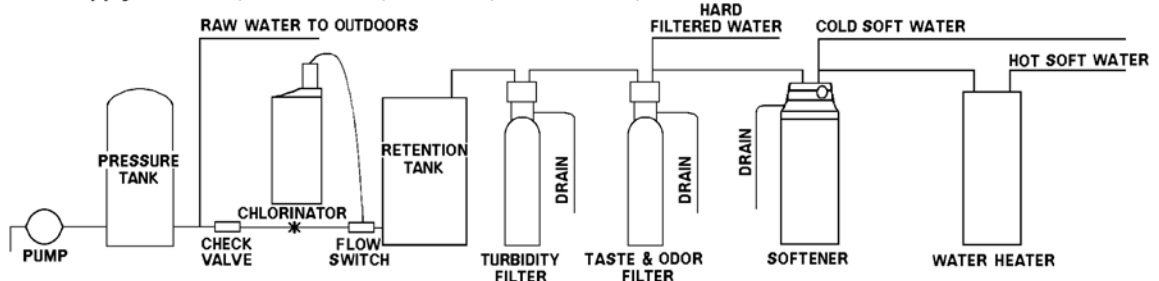

2. Attach the bypass valve to the control valve. Connect the inlet and outlet of the water filter to the plumbing in the house. The control valve must not be submitted to temperatures above 71°C (110°F). When sweat fittings are used, to avoid damaging the control valve, solder the threaded copper adapters to the copper pipe and then, using Teflon tape, screw the assembly onto the bypass valve.
CAUTION: Do not use pipe thread compound as it may attack the material in the valve body.
3. Using teflon tape, screw the 1/2" hose barb into the drain port in the valve. Attach 1/2" drain hose to the hose barb and tighten securely with a hose clamp. Run the drain line to a floor drain or a laundry drain. Complete any necessary plumbing.
4. Make sure the bypass valve is in the service position.
5. Plug the 24-volt transformer into a 120 VAC 60 Hz outlet. This valve has four positions: 1) Backwash 2) Brine/Rinse (not used) 3) Rapid Rinse and 4) Brine Refill (not used). When the valve is in the Service position, the extra cycle button (far left button as shown on Figure 4) must be pressed and held for 5 seconds before it activates. Press and hold the extra cycle button for 5 seconds to advance the valve to the "1" Backwash position. Slowly turn on the water supply and allow the unit to backwash until the air purges out of the tank and clears the system.
NOTE: On taste and odor filters, the initial water running to the drain will be very black. This is created by the carbon fines being flushed from the bed. Backwash all filters until the water running to the drain is clear.
6. Press the extra cycle button to advance the valve to the "2" position (not used). Press once more to advance to the "3" position. Press once more to advance to the "4" Brine refill position. Press the extra cycle button to advance the valve back into the service position indicated by the red dot in the upper left corner of the display.

Operating Instructions

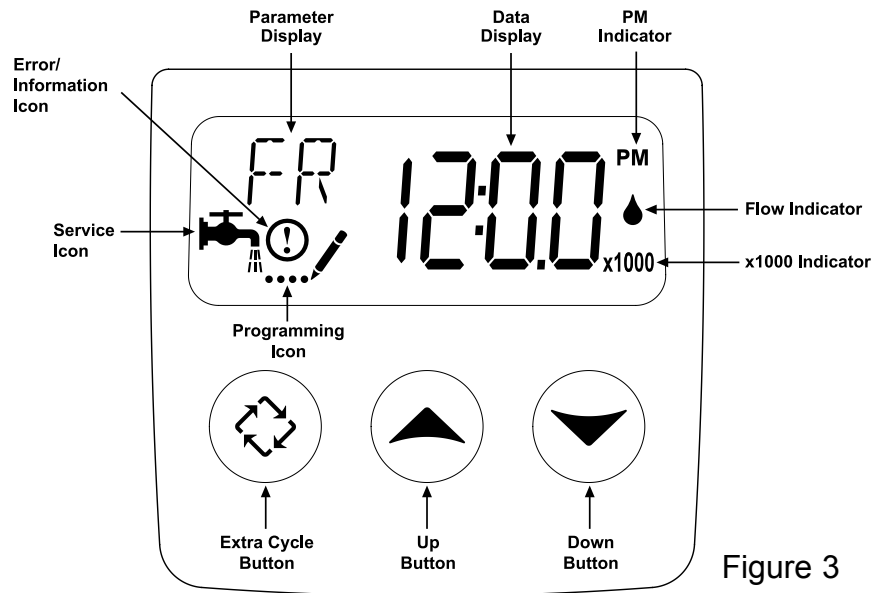

Figure 3

The valve has been pre-programmed with factory settings as follows:

Capacity between Regenerations 1,500 gallons

Regeneration Cycle Step Programming

1. Backwash 6 minutes
2. Brine Rinse..... 0 minutes (not used)
3. Rapid Rinse 5 minutes
4. Brine Refill 0 minutes (not used)

Whenever the valve is in Service the current time of day can be set, the control programmed, or an extra regeneration initiated at any time.

Set Time of Day

1. Press and hold either the Up or Down buttons until the programming icon replaces the service icon and the parameter display reads TD.
2. Adjust the displayed time with the Up and Down buttons.
3. When the desired time is set, press the Extra Cycle button to resume normal operation. The unit will also return to normal operation after 5 seconds if no buttons are pressed.

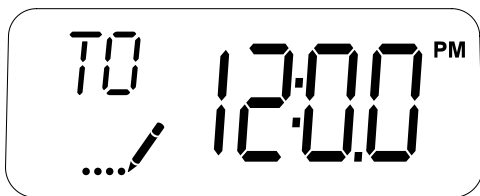

Queueing a Regeneration

1. Press the Extra Cycle button. The service icon will flash to indicate that a regeneration is queued.
2. To cancel a queued regeneration, press the Extra Cycle button.

Regenerating Immediately

Press and hold the Extra Cycle button for five seconds.

User Programming Mode Options		
Abbreviation	Parameter	Description
DO	Day Override	The timer's day override setting THIS IS AN OPTION ONLY. PLEASE DO NOT ADJUST BEFORE CONSULTING AN AUTHORIZED DEALER.
RT	Regeneration Time	The time of day that the system will regenerate (meter delayed, timeclock, and day-of-week systems)
RC	Reserve Capacity	The fixed reserve capacity
CD	Current Day	The current day of week

NOTES:

Some items may not be shown depending on timer configuration.

The timer will discard any changes and exit User Mode if any button is not pressed for sixty seconds.

User Programming Mode Steps

1. Press the Up and Down buttons for five seconds while in service, and the time of day is NOT set to 12:01 PM.
2. Use this display to adjust the Day Override. This option setting is identified by "DO" in the upper left hand corner of the screen.

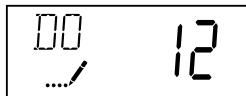

THIS IS AN OPTION ONLY. PLEASE DO NOT ADJUST BEFORE CONSULTING AN AUTHORIZED DEALER.

3. Press the Extra Cycle button. Use this display to adjust the Regeneration Time. This option setting is identified by "RT" in the upper left hand corner of the screen.

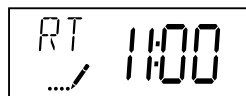

4. Press the Extra Cycle button. Use this display to adjust the Fixed Reserve Capacity. This option setting is identified by "RC" in the upper left-hand corner of the screen.

75 gallons X # of people in the house = RC

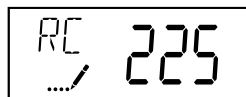

# of People	RC
1	75
2	150
3	225

5. Press the Extra Cycle button to end User Programming Mode.

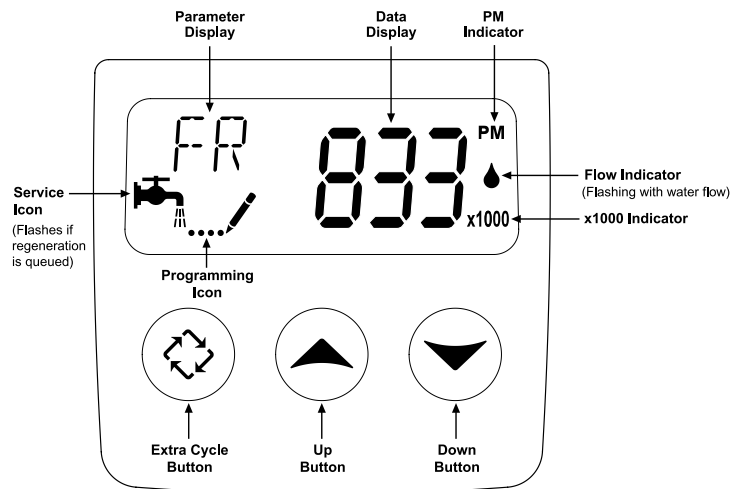

Set treated water capacity (only available in metered systems)

1. Set time of day to 12:01 PM.

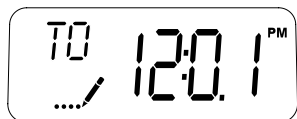

2. Press Extra Cycle button to exit the time of day display.
3. Press and hold the Up and Down buttons together until the programming icon replaces the service icon.
4. Press Extra Cycle button till "C" is displayed in the upper left corner of the screen.
5. Use Up and Down buttons to set the amount of treated water that can flow through the unit before a regeneration is required.

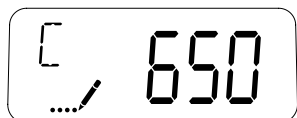

650 gallon capacity

6. Press Extra Cycle button until it shows the "Time of Day" display.

THIS IS AN OPTION ONLY. PLEASE DO NOT ADJUST BEFORE CONSULTING AN AUTHORIZED DEALER.

Error Codes

Note: Error codes appear on the In Service display

Error Code	Probable Cause	Recover and Resetting
[Err 0]	Drive motor is stalled	Unplug the unit from the power source
[Err 1]	Drive motor is running continuously	When power is restored to the unit, the Err _ display code clears. If the condition causing the error has not been resolved the Err _ code reappears in the four digit display. Do not attempt to troubleshoot this problem any further.
[Err 2]	There have been more than 99 days since the last Regeneration. If the Day of the Week mode of regeneration is selected and days since last regeneration exceeds 7 days. [7 - - 5]: There have been more than 7 days since the last regeneration. All individual settings (d1, d2, d3, d4, d5, d6, d7) are set to 0.	Regeneration must occur for the unit to recover, the display to clear and the valve to function normally. [7 - - 5]: To recover from [Err2], the user must initiate a regeneration or set at least one individual day to 1.
[Err 3]	Control board memory failure.	Perform a Master Reset. If the error returns, do not attempt to troubleshoot this problem any further.

Error Display Example

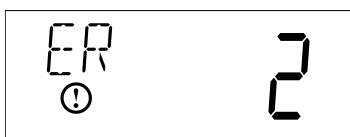

NOTE: Unit will flash when an error exists.

Start-Up Instructions

Water-only backwash

1. Check that the correct backwash (BW) flowrate has been determined based on the water temperature. (See table below)
2. Allow the tank to slowly fill with water from the bottom. This is most easily accomplished by setting the control valve to the backwash position and partially opening the inlet valve until water flows from the drain line.
3. Allow the media to soak for at least 30 minutes.
4. Fully open the inlet valve and set the control valve in the backwash position.
5. Depending on how critical the application is, allow the filter to backwash for 20 to 30 minutes. Continue the backwash until the water is clear and free of particles. This is backwash #1.
6. Allow the filter to settle for 10 to 15 minutes. Do not allow the control valve to enter the fast rinse cycle.
7. Depending on how critical the application is, allow the filter to backwash again for 15 to 20 minutes. This is backwash #2.
8. Allow the filter to fast rinse (downflow) for 5 to 8 minutes.
9. The filter is now ready for service.

Backwash Rate

Tank Diameter	8"	10"	12"	14"	16"	Reference
gpm@80°F	8	12	18	24	24	23 gpm/ft ²
gpm@70°F	7	11	16	21	21	20 gpm/ft ²
gpm@60°F	6	9	13	18	18	17 gpm/ft ²
gpm@50°F	5	8	12	16	16	15 gpm/ft ²
gpm@40°F	4	7	10	13	13	13 gpm/ft ²

Operating Instructions

Water Pressure

Your water filter is designed to operate under normal water pressures from 20 psi to 100 psi.

Regeneration and Automatic Bypass

Water filters are factory set to regenerate at 11:00 p.m. during a period of little or no water use. The regeneration cycle lasts approximately 15 minutes, after which filtered water service is restored. While regeneration is taking place, "raw water" automatically bypasses the filter if required. If possible, avoid using water during regeneration to prevent unfiltered water entering your household plumbing system.

(Installation Tip: The 7000SXT Filter should not be allowed to regenerate at the same time as any other water treatment units. If adjustment is required, consult programming chart to adjust default regeneration time.)

New Sounds

You will notice new sounds such as the hum of the timer, as your filter operates. During regeneration, it will not be uncommon to hear water running to the drain.

Manual Bypass (Figure 4)

In case of an emergency such as an overflowing brine tank, you can isolate your water softener from the water supply using the bypass valve located at the back of the control.

In normal operation the bypass is open with the ON/OFF knobs in line with the INLET and OUTLET pipes. To isolate the softener, simply rotate the knobs clockwise (as indicated by the word BYPASS and arrow) until they lock.

You can use your water related fixtures and appliances as the water supply is bypassing the softener. However, the water you use will be hard.

To resume soft water service, open the bypass valve by rotating the knobs counter-clockwise.

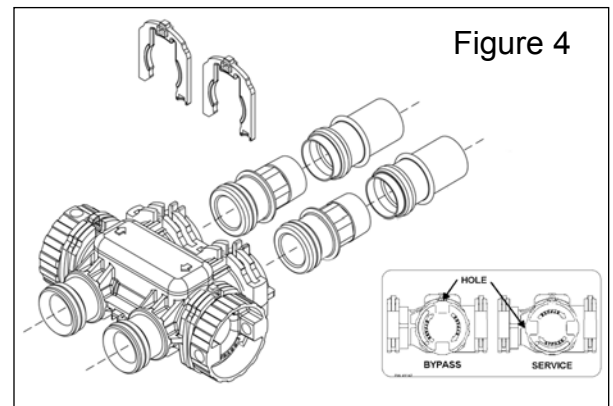

Manual Regeneration Cycle

If you run out of filtered water because of inadequate regeneration frequency, inadequate reserve capacity, power failure or unusually high water usage, you can initiate a manual regeneration simply by pressing the extra cycle button. The filter will now automatically complete a regeneration cycle and return to service. If possible, avoid water use during the regeneration cycle.

Once you have set your filter and you experience frequent loss of water pressure, you may have to increase the frequency of regeneration by resetting the gallons between regeneration.

Maintenance Instructions

Maintenance of your new water filter requires very little time or effort but it is essential. Regular maintenance will ensure many years of efficient and trouble free operation.

Care of all Water Filters

To retain the attractive appearance of your new water filter, clean occasionally with a mild soap solution. DO NOT use abrasive cleaners, ammonia or solvents. Never subject your filter to freezing.

Replacing Media Bed

Turbidity Filter (Multi-Media)

Under normal operating conditions the media should never need to be replaced. If you experience pressure loss and cannot correct it with a manual regeneration, your media bed may need replacing - contact your dealer.

Trouble Shooting Guide

PROBLEM	CAUSE	CORRECTION
1. Filter bleeds taste and odor or sediment	A. Bypass valve is open B. Electrical service to unit has been interrupted C. Defective or stripped media bed D. Quality of water has worsened E. Filter capacity too small F. Filter not backwashing enough G. Excessive water usage - calendar clock models	A. Close bypass valve B. Assure permanent electrical service (check fuse, plug or switch) C. Replace media D. Have water sample analyzed to determine any change E. Replace with larger unit or add another filter F. Be sure flow control is not clogged or drain line restricted. Be sure water pressure has not dropped and that pump has sufficient capacity G. Increase frequency of regeneration. Make sure there are no leaks in toilets or sinks
2. Filter fails to regenerate	A. Electrical service to unit has been interrupted B. Timer is defective C. Power failure D. Timer motor does not run	A. Assure permanent electrical service (check fuse, plug or switch) B. Replace timer C. Reset time of day D. Replace defective motor
3. Filter regenerates every day	A. Faulty gear train	A. Check the mechanical linkage on the timer control to eliminate possible binding in the gear train
4. Loss of water pressure	A. Iron or turbidity build-up in filter B. Filter not regenerating often enough C. Not enough water volume or pressure to backwash properly	A. Clean control and treat bed with Iron Out. Increase frequency of regeneration B. Increase frequency of regeneration C. Correct water supply problem
5. Loss of media through drain line	A. Air in water system B. Backwash rate too fast	A. Assure that well system has proper air eliminator control. Check for dry well condition. B. Check drain flow control for proper flow rates
6. Drain flows continuously	A. Foreign material in control B. Timer motor stopped or jammed	A. Remove piston assembly and inspect bore. Remove foreign material and check control in various regeneration positions B. Replace timer motor

GUARANTEE

HYDROTECH guarantees that your new water conditioner is built of quality material and workmanship. When properly installed and maintained, it will give years of trouble-free service.

FIVE YEAR COMPLETE PARTS GUARANTEE

HYDROTECH will replace any part which fails within 60 months from date of manufacture, provided the failure is due to a defect in material or workmanship. The only exception shall be when proof of purchase or installation is provided and then the warranty period shall be from the date thereof.

TEN YEAR GUARANTEE ON MINERAL TANKS

HYDROTECH will provide a replacement mineral tank to any original equipment purchaser in possession of a tank that fails within 120 months, provided that the water conditioner is at all times operated in accordance with specifications and not subject to freezing or exposure to direct sunlight.

GENERAL PROVISIONS

HYDROTECH assumes no responsibility for consequential damage as a result of escaped water from the water filter; labor or expense incurred as a result of a defect or for failure to meet the terms of these guarantees because of circumstances beyond its control.

WaterGroup Inc.

Fridley, MN

Rancho Cucamonga, CA

1-800-354-7867

Regina, SK

Cambridge, ON

Calgary, AB

1-877-299-5999

www.hydrotechwater.com