



# **6700<sub>XTR</sub> Valve Upflow**

---

## **Automatic Water Softeners Operation Manual**



# Performance and Specifications

Upflow Metered Model	Capacity at Various Salt Dosages grains				Service Flow Rate <sup>(2)</sup> USGPM	Backwash Flow Rate USGPM	Resin Volume cu. ft.	Mineral Tank Size <sup>(3)</sup> inches	Brine Tank Size <sup>(3)</sup> inches	Brine Tank Salt Capacity Lbs.	Shipping Weight Lbs.
	@15lb/cf	@10lb/cf <sup>(1)</sup>	@6lb/cf	@3lb/cf							
6700MIU-844-75	22,500	18,000	12,750	9,750	8	1.5	0.75	8 x 44	18 x 33	335	70
6700MIU-948-100	30,000	24,000	17,000	13,000	10	2.0	1.00	9 x 48	18 x 33	335	85
6700MIU-1047-125	37,500	30,000	21,250	16,250	12	2.4	1.25	10 x 47	18 x 33	335	110
6700MIU-1054-150	45,000	36,000	25,500	19,500	12	2.4	1.50	10 x 54	18 x 33	335	125
6700MIU-1252-200	60,000	48,000	34,000	26,000	13	3.5	2.00	12 x 52	18 x 33	335	150
6700MIU-1450-250	75,000	60,000	42,500	32,500	13	5.0	2.50	14 x 50	21 x 36	335	190

**Operating Temperature Range:** 34° to 110°F (1° to 43°C).

**Operating Pressure Range:** 20 to 120 psi (1.37 to 8.27 bar).

**Electrical:** 24V/60Hz with a supplied 120V/60Hz Wall Mount CSA Approved Transformer

**Caution:** These products are not intended to be used to treat water that is microbiologically unsafe or of unknown quality without adequate disinfection before or after the system.

**NOTES:** <sup>(1)</sup> 10lb/cu.ft. salt dosage is the standard factory setting.

<sup>(2)</sup> The Service Flow Rate given will not exceed a pressure drop of 15psi.

<sup>(3)</sup> Dimensions of cylindrical tanks shown are diameter (or width) x height. Cabinets shown as length x width x height.

The manufacturer reserves the right to make product improvements which may deviate from the specifications and descriptions shown above, without obligation to change previously manufactured products or to note the change.

## How Your Water Conditioner Works

Hard water enters your home through the main supply line, enters your water conditioner, and passes down through a bed of ion exchange resin which softens the water. An ion exchange process takes place in which the resin beads capture and hold calcium and magnesium, the hardness impurities, while the water takes on sodium ions. The soft water then flows up and into your household water line.

On the days your water conditioner regenerates, the resin is automatically recharged by passing a brine solution (salt water) through it. This reverses the ion exchange process, charging the resin with sodium and freeing the hardness minerals. These minerals and the brine solution are then flushed away through the drain line followed by a rapid rinse. The resin bed is again ready to soften water.

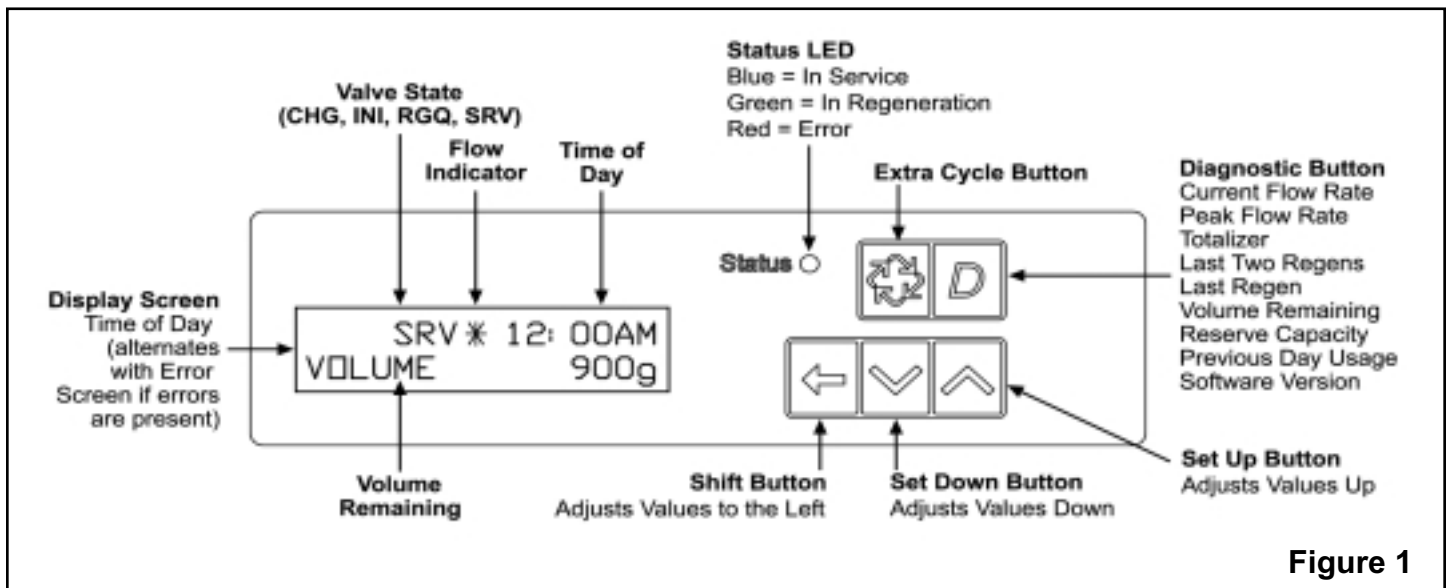

**Figure 1**

**Valve State:**

**CHG (Change of State)**

CHG will be displayed when the lower drive changes from one state to another in dual piston valves.

**INI (Initializing)**

INI will display on the screen for 30 to 45 seconds when initializing after a power failure reset or programming.

**RGQ (Regeneration Queued)**

RGQ indicates that the reserve has been entered in a delayed system and regeneration has been queued. When in the main screen, press the Shift button to toggle service (SRV) with RGQ.

**Service (SRV)**

SRV will display when the unit is in service.

**LED Status Lights:**

**Blue LED:**

Illuminates while the unit is in service and no errors exist. The unit will always be in service unless a regeneration trigger has occurred (green LED light will be displayed).

**Green LED:**

Illuminates when the unit is in Regeneration mode, unless an error condition exists.

**Red LED:**

Illuminates when there is an error.

## Model 6700XTR Programming Chart - Customer Use

To enter USER PROGRAMMING MODE, press and hold the Up and Down buttons for 5 seconds.

NOTE: Depending on current option settings, some displays cannot be viewed or set.

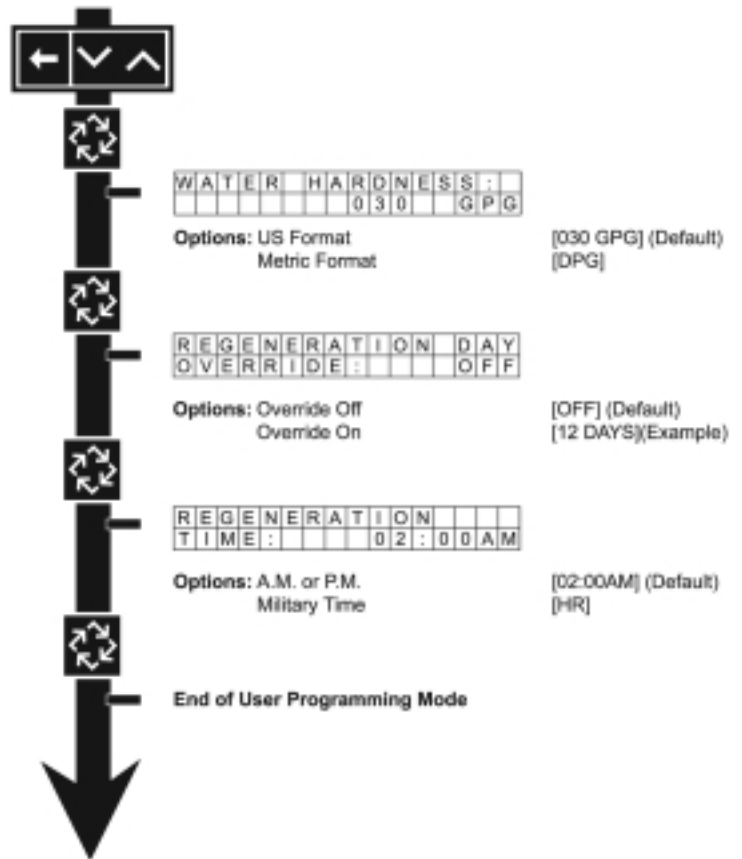

# Installation Instructions

**All government codes and regulations governing the installation of these devices must be observed.**

**CAUTION:** If the ground from the electrical panel or breaker box to the water meter or underground copper pipe is tied to the copper water lines and these lines are cut during installation of the Noryl bypass valve and/or poly pipe, an approved grounding strap must be used between the two lines that have been cut in order to maintain continuity. The length of the grounding strap will depend upon the number of units being installed and/or the amount of copper pipe being replaced with poly. See Figure 2.

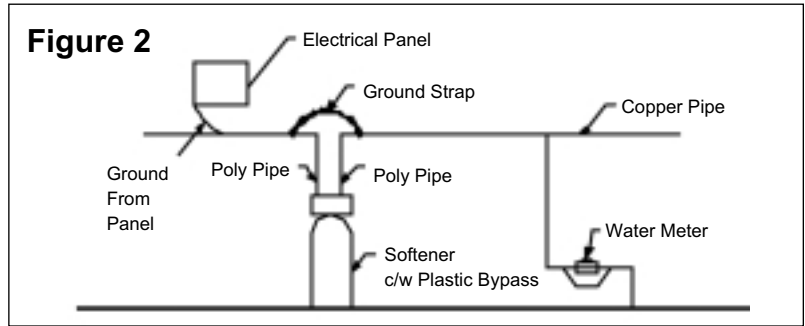

In all cases where metal pipe was originally used and is later interrupted by poly pipe or the Noryl bypass valve as in Figure 2 or by physical separation as in Figure 3, an approved ground clamp with no less than #6 copper conductor must be used for continuity, to maintain proper metallic pipe bonding.

Check your local electrical code for the correct clamp and cable size.

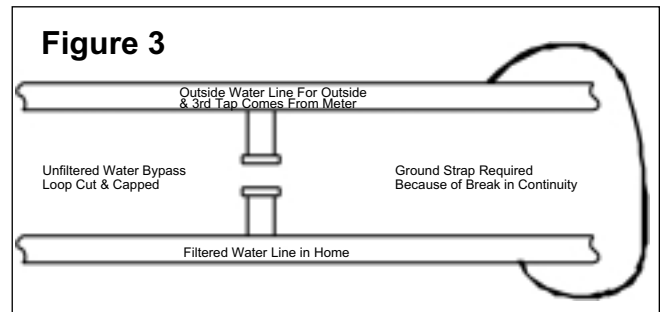

1. Position the conditioner on a flat surface, near a drain and a 115 volt AC outlet. The unit is provided with a 24V adapter.
2. Study the layout of the present water lines and drains in order that you can determine the best location for your water conditioner and plan your installation. Your conditioner must not be subjected to freezing or to water temperatures above 110°F which will void the warranty.
3. All plumbing should be done in accordance with local plumbing codes. The pipe size for the drain line should be a minimum of 1/2". However, a 3/4" drain line is required where backwash flow rates are in excess of 7 gpm or the length of the drain line is greater than 20 feet.
4. Soldering joints near the drain must be done prior to connecting the drain line flow control (DLFC). Leave at least 6" between the DLFC and the solder joints when soldering pipes that are connected on the DLFC. Failure to do this could cause interior damage to the DLFC.
5. Teflon tape is the only sealant to be used on the drain fitting.
6. Make sure that the floor is clean and level beneath the salt storage tank.

## Media Installation (When Necessary)

- Remove the valve from the mineral tank.
- Temporarily plug the open end of the riser tube to ensure that no resin or gravel falls down into the distribution.
- Fill mineral tank one quarter full of water to protect distribution during gravel installation.
- Slowly and carefully add the gravel support bed and the softener or filtration media leveling each layer as it is placed into the tank.
- Unplug the riser tube, carefully position the valve over it and turn the valve into the threads in the fiberglass tank, tightening securely into tank. Note: Ensure that the internal O-ring in the valve fits securely over the riser tube. Silicone grease (#13691) or other food grade lubricant may be applied to the O-ring to ease installation of the riser tube. DO NOT use petroleum based lubricants as they will cause swelling of O-ring seals.
- The softener or filter is now charged with softening resin.
- It is recommended that the softener or filter tank now be completely filled with water (SLOWLY) to soak the resin or filtration media before startup. This will allow the media to absorb water as well as help displace any trapped air. This will reduce the chance of backwashing resin or filter media out of the tank during the initial backwash on startup.

## Installation Instructions Cont'd

7. Place approximately 1" of water above the grid plate. If a grid is not utilized, fill to the top of the air check in the salt tank. Do not add salt to the brine tank at this time.
8. On units with a bypass, place in BYPASS position. Turn on the main water supply. Open a cold soft water tap nearby and let run a few minutes or until the system is free from foreign material (usually solder) that may have resulted from the installation. Once clean, close the water tap.
9. Place the bypass in the SERVICE position and let water flow into the mineral tank. When water flow stops, slowly open a cold water tap nearby and let run until the air is purged from the unit.
10. Plug unit into an electrical outlet. NOTE: all electrical connections must be connected according to local codes.
11. In normal operation the Time of Day and Volume Remaining is displayed. Set the Time of Day by:
  - Press and hold the Up or Down button for 2 seconds.
  - Press the Shift button to select the digit you want to modify.
  - Press the Up or Down buttons to adjust the value.
  - Press the Extra Cycle button to return to the normal display screen, or after a 5 second timeout.NOTE: The "D" button (Diagnostic) can be pressed to exit without saving.
12. The Volume Remaining Display is the volume of water (in US gallons) remaining prior to regeneration, including any reserve capacity. Without any water usage, the Flow Indicator (line) will be motionless. Open a soft water tap. A rotating line (appearing as a rotating star shape) will display on the screen when flow is going through the meter. Close the tap after 3-5 gallons of water flow.
13. Initiate a manual regeneration cycle by pressing and holding the extra cycle button for 5 seconds. The piston will move to the 1st cycle which is BRINE SLOW RINSE. Press the Extra Cycle button again and the piston will advance to the 2nd cycle which is BACKWASH. Allow the water to run to drain for 3-4 minutes to purge the air out of the tank. Press the Extra Cycle button again and the piston will advance to the 3rd cycle which is RAPID RINSE. Press the extra cycle button again and the piston will advance to the 4th cycle which is BRINE REFILL. Press the extra cycle button again and the piston will advance to the SERVICE position.
14. Add water to the brine tank to the top of the air check. Manually step the valve to the BRINE/RINSE position (see Step 13) and allow the valve to draw water from the brine until it stops.  
Note: the air check will check at approximately the midpoint of the screened intake area.
15. Manually step the valve back to the SERVICE position.
16. With the valve in service, check that there is about 1" of water above the grid in the brine tank, if used.
17. Fill the brine tank with salt.

**(Installation Tip: The 6700XTR Softener should not be allowed to regenerate at the same time as any other water treatment units. If adjustment is required, consult programming chart to adjust default regeneration time.)**

**Optional Sanitization Procedure:** We recommend that all new water conditioners be disinfected as part of the startup. Sanitization is achieved by the application of chlorine in the regeneration cycle of the conditioner. A liquid solution of 5.25% sodium hypochlorite (commonly referred to as household bleach) is recommended as a suitable disinfectant. Use only unscented products. For every cubic foot of resin in the softener, pour approximately two (2) tablespoons of sodium hypochlorite into the brine well tube. Press and hold the EXTRA CYCLE button and allow the brine tank to fill with the standard amount of water. Press the EXTRA CYCLE button again twice to advance the valve to the Brine/Rinse position. Allow softener to complete the Brine/Rinse cycle, then press EXTRA CYCLE button three times to advance valve back to service position.

# Operating Instructions

## Water Pressure

Your conditioner is designed to operate under normal water pressures from 20 psi to 100 psi.

## Regeneration and Automatic Bypass

Water conditioners are factory set to regenerate at 2:00 a.m. during a period of little or no water use. The regeneration cycle lasts approximately two hours, after which soft water service is restored. While regeneration is taking place, hard water automatically bypasses the water conditioner if required. Use of water, particularly hot water, should be avoided at this time to prevent hard water from filling the water heater.

## New Sounds

You will notice new sounds as your conditioner operates, such as the hum of the timer or click of the actuator arm. During regeneration, it will be common to hear the sounds of water running to the drain.

## Manual Bypass (Figure 4)

In case of an emergency such as an overflowing brine tank, you can isolate your water softener from the water supply using the bypass valve located at the back of the control.

In normal operation the bypass is open with the ON/OFF knobs in line with the INLET and OUTLET pipes. To isolate the softener, simply rotate the knobs clockwise (as indicated by the word BYPASS and arrow) until they lock.

You can use your water related fixtures and appliances as the water supply is bypassing the softener. However, the water you use will be hard.

To resume soft water service, open the bypass valve by rotating the knobs counter-clockwise.

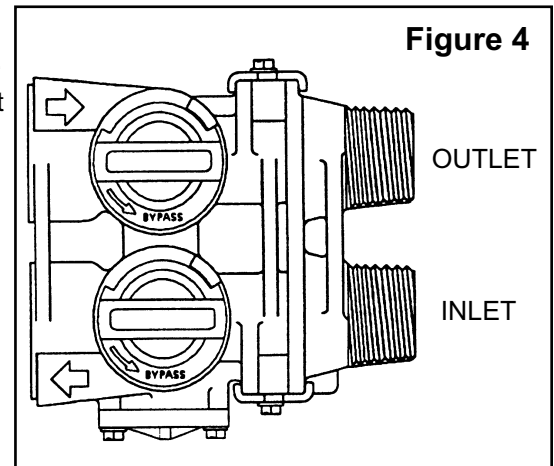

# Maintenance Instructions

## Checking the Salt Level

Check the salt level monthly. Remove the lid from the cabinet or brine tank, make sure salt level is always above the brine level (you should not be able to see water).

## Adding Salt

Use only clean salt labeled for water conditioner use, such as crystal, pellet, nugget, button or solar.

The use of rock salt is discouraged because it contains insoluble silt and sand which build up in the brine tank and can cause problems with the system's operation.

Add the salt directly to the tank, filling no higher than the top of the brine well.

## Caution

Liquid brine will irritate eyes, skin and open wounds - gently wash exposed area with fresh water. Keep children away from your water conditioner.

## Resin Cleaner

An approved resin cleaner must be used on a regular basis if your water supply contains iron. The amount of resin cleaner and frequency of use is determined by the quantity of iron in your water (consult your local representative or follow the directions on the resin cleaner package).

## Care of Your Water Conditioner

To retain the attractive appearance of your new water conditioner, clean occasionally with a mild soap solution. Do not use abrasive cleaners, ammonia or solvents. Never subject your conditioner to freezing.

## Bridging (Figure 5)

Humidity or the wrong type of salt may create a cavity between the water and the salt. This action, known as "bridging", prevents the brine solution from being made, leading to your water supply being hard.

If you suspect salt bridging, carefully pound on the outside of the plastic brine tank or pour some warm water over the salt to break up the bridge. This should always be followed up by allowing the unit to use up any remaining salt and then thoroughly cleaning out the brine tank. Allow four hours to produce a brine solution, then manually regenerate the softener.

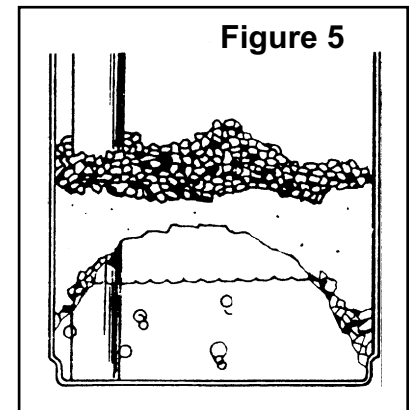

## Cleaning The Injector Assembly (Figure 6)

Sediment, sand and silt will restrict or clog the injector. A clean water supply and pure salt will prevent this from happening.

The injector assembly is located on the left side of the control valve. This assembly is easy to clean.

Shut off the water supply to your water conditioner and reduce the pressure by opening a cold soft water faucet. Using a screwdriver, remove the two screws holding the injector assembly to the control valve body. Carefully remove the assembly and disassemble as shown in Figure 6. The injector orifice is removed from the injector body by carefully turning it out with a screwdriver. Remove the injector throat the same way. Carefully flush all parts with water. Use a mild acid such as vinegar or Pro-Rust Out to clean the small holes in the orifice and throat. Reassemble using the reverse procedure.

Do not over tighten.

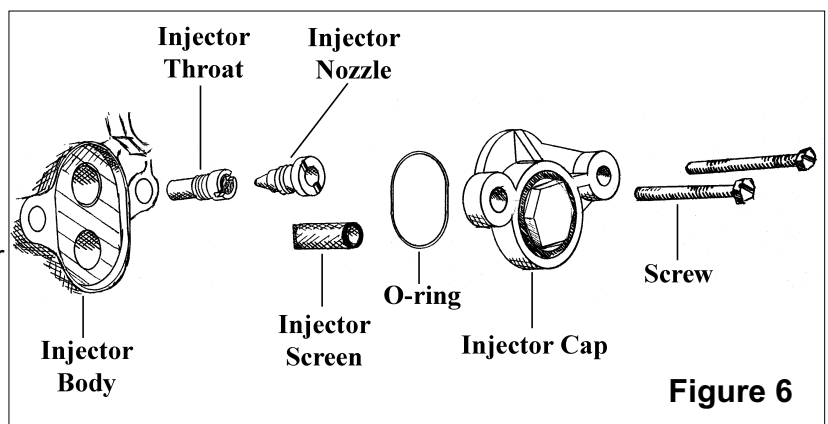



## Troubleshooting

If an error is detected, an error screen will alternate with the main display screen every few seconds, and the LED light will be red.

### Error Codes

<b>Error Code</b>	<b>Display Message</b>	<b>Correction</b>
01	ERROR CODE: PROGRAM UNIT	Contact Your Dealer for Service.
02	ERROR CODE: PROGRAM UNIT	
03	ERROR CODE: SERVICE UNIT	
04	ERROR CODE: SERVICE UNIT	
05	ERROR CODE: SERVICE UNIT	

# Trouble Shooting Guide

<p><b>1. CONDITIONER DELIVERS HARD WATER</b></p> <p>A. Bypass valve is open          B. No salt in brine tank          C. Injector or screen plugged          D. Insufficient water flowing into brine tank          E. Hot water tank hardness          F. Leak at distributor tube          G. Internal valve leak          H. Flow meter jammed          I. Flow meter cable disconnected or not plugged          J. Improper programming</p>	<p>A. Close bypass valve          B. Add salt to brine tank and maintain salt level above water level          C. Replace injectors and screen          D. Check brine tank fill time and clean brine line flow tank control if plugged          E. Repeated flushing of the hot water tank is required          F. Make sure distributor tube is not cracked. Check O ring and tube pilot          G. Replace seals and spacers and/or piston          H. Remove obstruction from flow meter          I. Check meter cable connection to timer and meter cap into meter cap          J. Re-program the control to the proper regeneration type, inlet water hardness, capacity or flow meter size.</p>
<p><b>2. CONDITIONER FAILS TO REGENERATE</b></p> <p>A. Electrical service to unit has been interrupted          B. Timer is not operating properly          C. Defective valve drive motor          D. Improper programming</p>	<p>A. Assure permanent electrical service (check fuse, plug, chain or switch)          B. Replace timer          C. Replace drive motor          D. Check programming and reset as needed</p>
<p><b>3. UNIT USES TOO MUCH SALT</b></p> <p>A. Improper salt setting          B. Excessive water in brine tank          C. Improper programming</p>	<p>A. Check salt usage and salt setting          B. See #7          C. Check programming and reset as needed</p>
<p><b>4. LOSS OF WATER PRESSURE</b></p> <p>A. Iron build-up in line to water conditioner          B. Iron build-up in water conditioner            C. Inlet of control plugged due to foreign material broken loose from pipes by recent work done on plumbing system</p>	<p>A. Clean line to water conditioner          B. Clean control and add resin cleaner to resin bed. Increase frequency of regeneration          C. Remove piston and clean control</p>
<p><b>5. LOSS OF RESIN THROUGH DRAIN LINE</b></p> <p>A. Air in water system            B. Drain line flow control is too large</p>	<p>A. Assure that well system has proper air eliminator control. Check for dry well condition.          B. Ensure drain line flow control is sized</p>
<p><b>6. IRON IN CONDITIONED WATER</b></p> <p>A. Fouled resin bed            B. Iron content exceeds recommended parameters</p>	<p>A. Check backwash, brine draw and brine tank fill. Increase frequency of regeneration. Increase backwash time.          B. Add iron removal filter system</p>
<p><b>7. EXCESSIVE WATER IN BRINE TANK</b></p> <p>A. Plugged drain line flow control          B. Brine valve failure          C. Improper programming</p>	<p>A. Clean flow control          B. Replace brine valve          C. Check programming and reset as needed</p>
<p><b>8. SALT WATER IN SERVICE LINE</b></p> <p>A. Plugged injector system          B. Timer not operating properly          C. Foreign material in brine valve          D. Foreign material in brine line flow control          E. Low water pressure          F. Improper programming</p>	<p>A. Clean injector and replace screen          B. Replace timer          C. Clean or replace brine valve          D. Clean brine line flow control          E. Raise water pressure          F. Check programming and reset as needed</p>
<p><b>9. CONDITIONER FAILS TO DRAW BRINE</b></p> <p>A. Drain line flow control is plugged          B. Injector is plugged          C. Injector screen is plugged          D. Line pressure is too low          E. Internal control leak          F. Improper programming          G. Timer not operating properly</p>	<p>A. Clean drain line flow control          B. Clean or replace injectors          C. Replace screen          D. Increase line pressure (line pressure must be at least 20 psi at all times)          E. Change seals and spacers and/or piston assembly          F. Check programming and reset as needed          G. Replace timer</p>
<p><b>10. CONTROL CYCLES CONTINUOUSLY</b></p> <p>Timer not operating properly          Faulty microswitches and/or harness          Faulty cycle cam operation</p>	<p>A. Replace timer          B. Replace faulty microswitch or harness          C. Replace cycle cam or reinstall</p>
<p><b>11. DRAIN FLOWS CONTINUOUSLY</b></p> <p>A. Foreign material in control            B. Internal control leak          C. Control valve jammed in brine or backwash position          D. Timer motor stopped or jammed teeth          E. Timer not operating properly</p>	<p>A. Remove piston assembly and inspect bore. Remove foreign material and check control in various regeneration positions          B. Replace seals and/or piston assembly          C. Replace piston and seals and spacers          D. Replace timer motor and check all gears for missing teeth          E. Replace timer</p>



# **GUARANTEE**

**HYDROTECH** guarantees that your new water conditioner is built of quality material and workmanship. When properly installed and maintained, it will give years of trouble-free service.

## **FIVE YEAR COMPLETE PARTS GUARANTEE**

**HYDROTECH** will replace any part which fails within 60 months from date of manufacture, provided the failure is due to a defect in material or workmanship. The only exception shall be when proof of purchase or installation is provided and then the warranty period shall be from the date thereof.

## **TEN YEAR GUARANTEE ON MINERAL AND BRINE TANKS**

**HYDROTECH** will provide a replacement mineral or brine tank to any original equipment purchaser in possession of a tank that fails within 120 months, provided that the water conditioner is at all times operated in accordance with specifications and not subject to freezing or exposure to direct sunlight.

## **GENERAL PROVISIONS**

**HYDROTECH** assumes no responsibility for consequential damage as a result of escaped water from the water filter; labor or expense incurred as a result of a defect or for failure to meet the terms of these guarantees because of circumstances beyond its control.