

**INSTALLATION
OPERATION
AND
MAINTENANCE
MANUAL**

**MODELS
DLR-AP**

SERIES NO'S

- 1**
- 2**
- 4**
- 7**

Sold by:

Manufactured by:

WEDECO Ideal Horizons, Inc.
3520 Westinghouse Blvd.
Charlotte, NC 28273
TEL: (704) 716-7600
FAX: (704) 716-7601
www.wedecouv.com

WEDECO

DLR SERIES ULTRAVIOLET WATER DISINFECTION UNIT

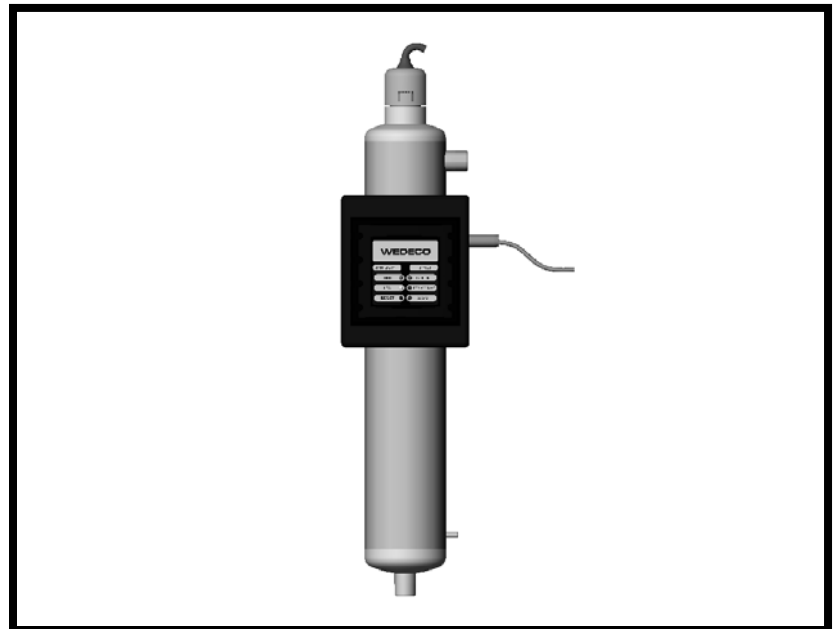

CAUTION

IT IS VERY IMPORTANT THAT THOSE RESPONSIBLE FOR THE INSTALLATION OF THIS EQUIPMENT, AS WELL AS THE OWNER/OPERATOR, READ THIS MANUAL AND CAREFULLY FOLLOW THE INSTRUCTIONS AND GUIDELINES.





Table of Contents

Important Safety Instructions.....	3
Pre-Installation Instructions.....	4-6
Installing the Disinfection Unit.....	8
Mounting Electrical Control Box.....	9
Installing the UV Lamp	10-10
Pre-Start Up Sequence	12
Start-Up Sequence	13
Maintenance.....	14-15
Maintenance Log	16
Parts List	18
Alarms.....	19
Troubleshooting.....	20
Technical Specifications: DLR Series	21-21
Warranty	23

Important Safety Instructions

WARNING! To guard against injury, basic safety precautions must be observed.

READ AND FOLLOW ALL SAFETY INSTRUCTIONS AND SAFE THESE INSTRUCTIONS

	CAUTION! Denotes a potentially dangerous situation. Failure to observe this warning may lead to minor or serious personal injury and material damage.
	ELECTRIC SHOCK! Warning — Dangerous electric voltage. Failure to observe this warning may lead to serious injury or death.
	EYE PROTECTION MUST BE WORN!
	IMPORTANT! Denotes a useful tip and other information.



CAUTION! Ultraviolet light (UV-C) is harmful to eyes and skin. Use UV lamps only inside the disinfection chamber with the appropriate protective covering. Avoid exposure to UV-C radiation.



CAUTION! Use disinfection unit only for its intended purpose as described in the Owner's Manual. The use of attachments not recommended or sold by WEDECO may cause an unsafe condition.



CAUTION! Disinfection unit must be properly installed in accordance with the Owner's Manual and in compliance with all applicable local and state regulations before use. Read and observe all important notices on the disinfection unit.



CAUTION! The WEDECO DLR Series UV disinfection unit is intended for indoor use only.



ELECTRIC SHOCK! To avoid possible electrical shock, take special care when using water with this equipment. Always shut off and disconnect power to the unit before:

- Making repairs (We strongly recommend that a qualified individual who fully understands the Owner's Manual perform service and/or repairs.)
- Cleaning
- Replacing a UV lamp



ELECTRIC SHOCK! Do not operate any disinfection unit if it has a damaged cord or plug, if it is malfunctioning, or if it is dropped or damaged in any way.



ELECTRIC SHOCK! The power cord of disinfection unit is equipped with a 3-prong grounding plug that mates with a standard 3-prong grounded wall outlet to minimize the possibility of electric shock. Be sure the outlet for the disinfection unit is wired and grounded properly. **Do Not** under any circumstances cut or remove the third prong from the power cord.



ELECTRIC SHOCK! Always unplug disinfection unit from outlet when not in use, before putting on or taking off parts, and before cleaning. Never unplug by pulling on the power cord. Always grip plug firmly and pull straight out of the outlet.



CAUTION! Shut down system before servicing:

- Turn off water supply to the UV disinfection unit.
- Disconnect all power to the UV disinfection unit.
- Drain water from the system.



EYE PROTECTION MUST BE WORN! *Never* look at an operating UV light with the naked eye. The light will burn and irritate unprotected eyes and skin.



EYE PROTECTION MUST BE WORN! *Never* operate the UV lamp outside of the UV disinfection unit.

Pre-Installation Instructions

IMPORTANT

Please read before installing your Ultraviolet System

When this unit is wired in conjunction with another electrical device you may experience a drop in voltage. It is recommended that your Ultraviolet System NOT share a circuit with another electrical device. The maximum voltage threshold for this system is 130V. The minimum voltage threshold for this system is 105V. Please ensure that proper voltage requirements are met before installing your Ultraviolet System.

Please read before installing your Ultraviolet System

IMPORTANT

Before you begin

Perform the following pre-installation steps:

Step	Action																					
1	Ensure that your DLR system is correct for your flow capacity (see Flow Rate Tables in Technical Specifications.)																					
2	<p>Ensure that your water supply meets water quality standards as shown in the table below. If any of the elements exceed the recommended maximum, we strongly suggest, at a minimum, that you install a 5-micron sediment filter as particles in the water can reduce UV light intensity and affect performance. Contact the distributor for additional information about testing and pretreatment equipment.</p> <table border="1"> <thead> <tr> <th>Element</th> <th>Recommended maximum levels (1mg/l = 1ppm)</th> <th>Actual</th> </tr> </thead> <tbody> <tr> <td>Suspended solids</td> <td><5 mg/l</td> <td></td> </tr> <tr> <td>Color</td> <td>None</td> <td></td> </tr> <tr> <td>Iron</td> <td>0.3 mg/l</td> <td></td> </tr> <tr> <td>Manganese</td> <td>0.05 mg/l</td> <td></td> </tr> <tr> <td>pH</td> <td>6.5 to 9.5</td> <td></td> </tr> <tr> <td>Hardness</td> <td><120 ppm</td> <td></td> </tr> </tbody> </table> <p>Note: All models are rated for a minimum UV transmission of 90%. If your transmission is lower, consult the distributor.</p>	Element	Recommended maximum levels (1mg/l = 1ppm)	Actual	Suspended solids	<5 mg/l		Color	None		Iron	0.3 mg/l		Manganese	0.05 mg/l		pH	6.5 to 9.5		Hardness	<120 ppm	
Element	Recommended maximum levels (1mg/l = 1ppm)	Actual																				
Suspended solids	<5 mg/l																					
Color	None																					
Iron	0.3 mg/l																					
Manganese	0.05 mg/l																					
pH	6.5 to 9.5																					
Hardness	<120 ppm																					
3	<p>Check the pressure of the water supply. The WEDECO UV system is designed to operate at pressures up to 125 psi.</p> <table border="1"> <thead> <tr> <th>If the pressure is...</th> <th>Then...</th> </tr> </thead> <tbody> <tr> <td>Less than 125 psi</td> <td>Proceed to step 3</td> </tr> <tr> <td>Greater than 125 psi</td> <td>Install a suitable pressure-reducing valve in the water inlet pipe to the disinfection unit.</td> </tr> </tbody> </table>	If the pressure is...	Then...	Less than 125 psi	Proceed to step 3	Greater than 125 psi	Install a suitable pressure-reducing valve in the water inlet pipe to the disinfection unit.															
If the pressure is...	Then...																					
Less than 125 psi	Proceed to step 3																					
Greater than 125 psi	Install a suitable pressure-reducing valve in the water inlet pipe to the disinfection unit.																					
4	<p>Fill in the following information and retain for future reference.</p> <p>Unit Model No. _____ Serial No. _____</p> <p>Date Purchased: _____ Date Installed: _____</p> <p>Water pressure (psi): _____ Water flow rate (gpm): _____</p>																					

- | | |
|---|---|
| 5 | <p>Select a location that meets the following guidelines.</p> <ul style="list-style-type: none">• The unit must be installed between the cold water source and the water heater as inlet temperature must not exceed 100°F. (See Figure 1 for proper installation sequence.)• The disinfection unit can be installed either horizontally or vertically. (See Figure 3 for water flow direction.)• There must be enough clearance to remove the UV lamp and the quartz sleeve for replacement and regular maintenance. Recommended clearance is length of unit plus four inches. (See Figure 4 for additional clearance requirements.)• The unit must be within 7 feet of an 110V electrical outlet. A 7'5" cord is included with the unit.• The unit must be protected from freezing. Freezing damage will void the warranty.• The unit should be placed where a potential leak will not cause water damage. WEDECO is not responsible for water damage. |
|---|---|

Pre-Installation Instructions, Continued

**Figure 1:
Installation
Sequence**

Figure 1 shows a typical installation sequence. Note that all items may not be necessary for water treatment.

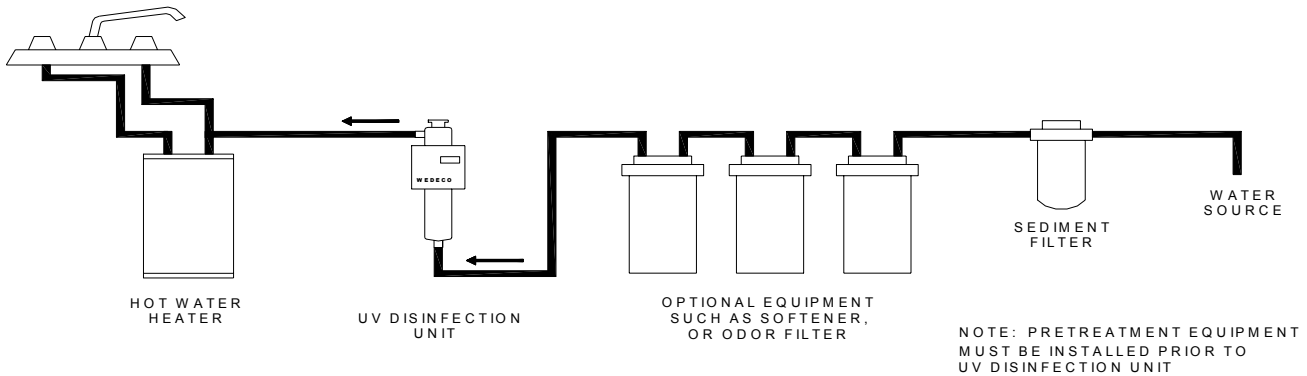

**Figure 2:
Installation
Planning**

You must determine how to run pipes in and out of your disinfection unit. Figure 2 shows one method of installation (with chamber mounted control box). Use this diagram to determine the materials needed for your installation.

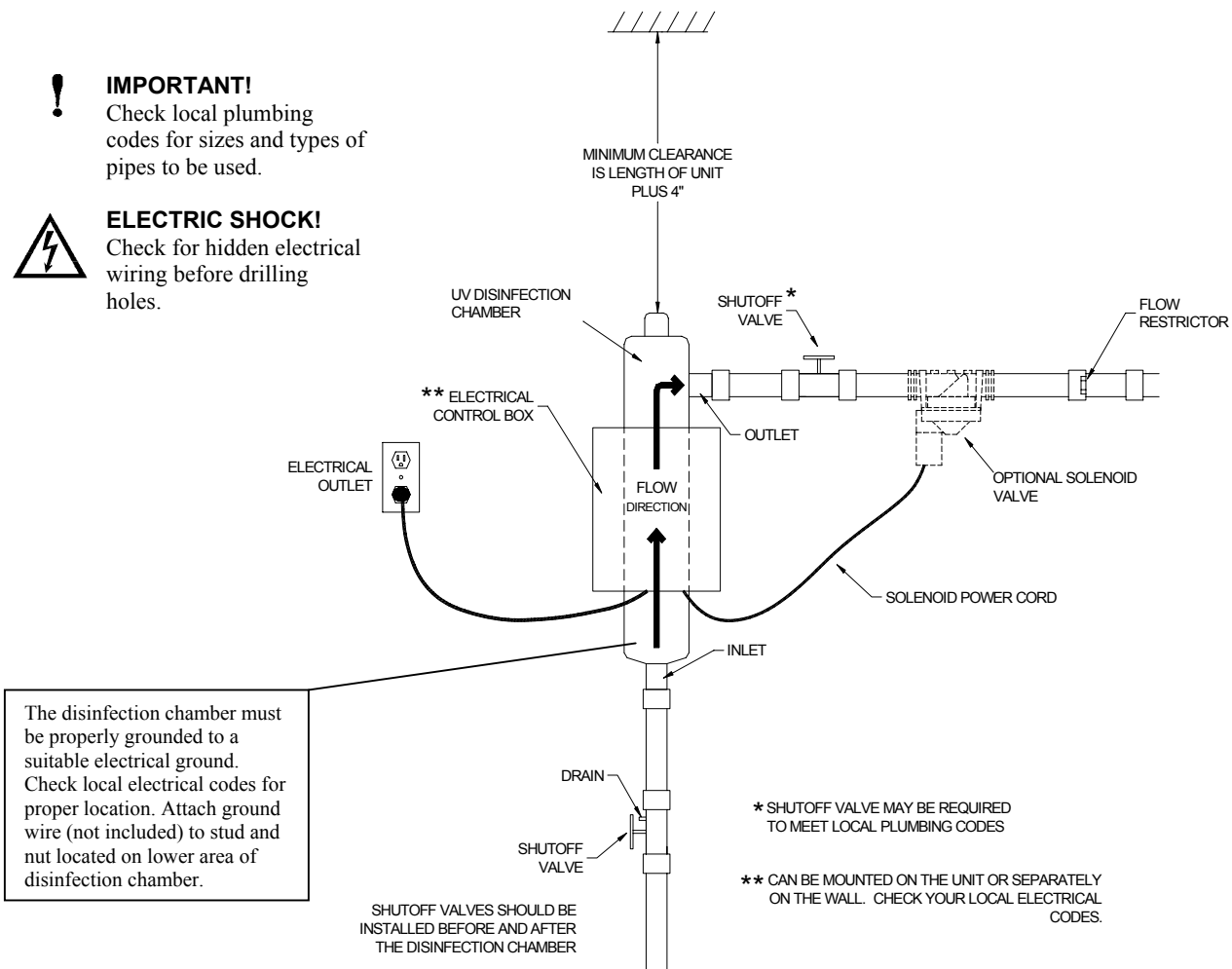

Pre-Installation Instructions, Continued

Figure 3: Unit Positioning

Figure 3 shows proper water flow for horizontal or vertical installation. Make certain that your unit and the inlet and outlet pipes are in the right position for either horizontal or vertical installation.

! IMPORTANT!
For vertical installation, the inlet is at the bottom and the outlet is near the top of the disinfection chamber. For horizontal installation pay careful attention to the diagram for flow direction.

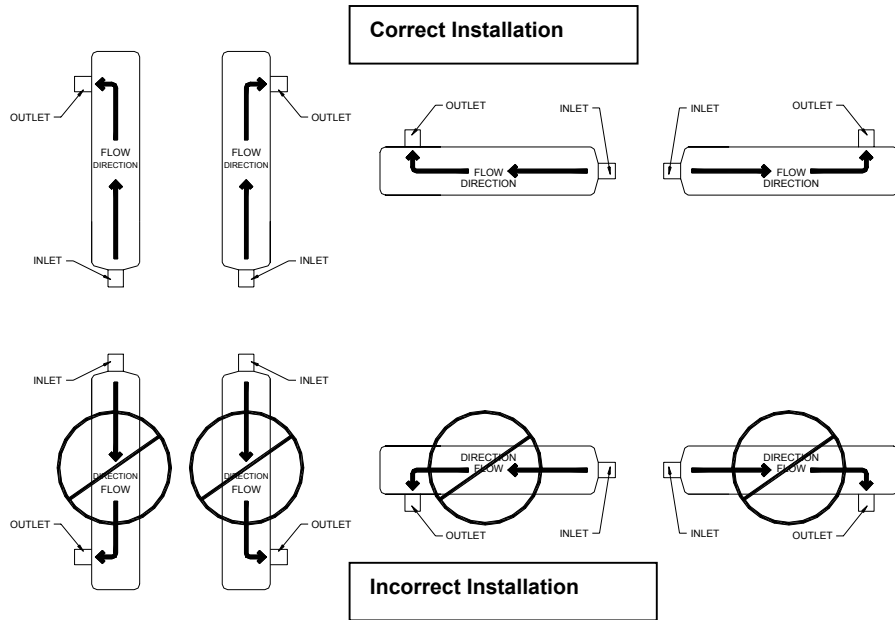
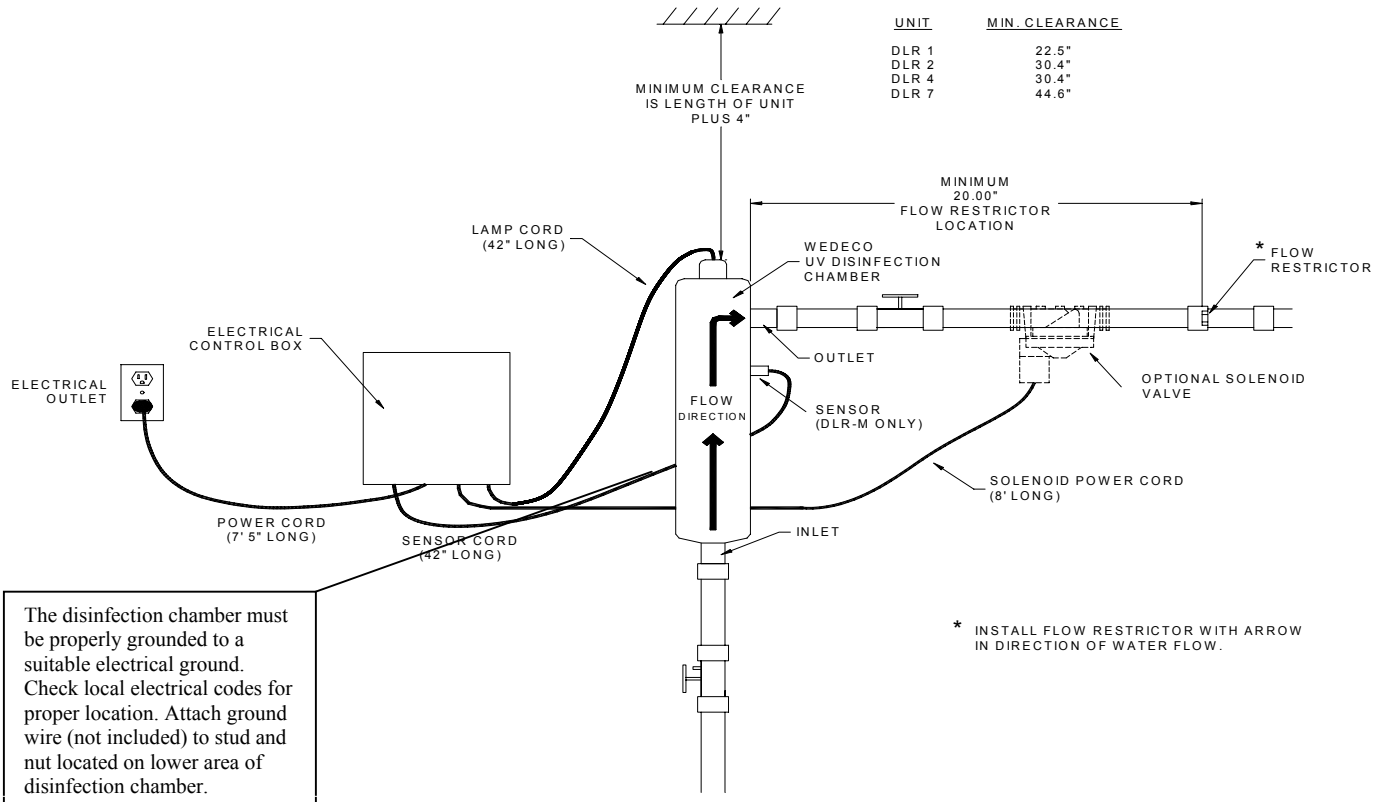

Figure 4: Clearance Requirements

Figure 4 provides the clearance requirements needed for proper installation of the disinfection chamber.



The disinfection chamber must be properly grounded to a suitable electrical ground. Check local electrical codes for proper location. Attach ground wire (not included) to stud and nut located on lower area of disinfection chamber.

Installing the Disinfection Unit

Attaching unit to wall Follow these steps to attach WEDECO UV disinfection chamber to the wall.

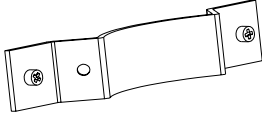
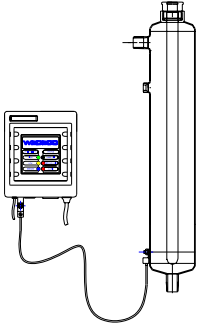
Step	Action	Diagram
1	Install the two wall mount brackets on the wall using the proper screws for your wall type (screws not included).	
2	Place disinfection chamber in the brackets and secure with the wall mount bracket straps. Use the wall mount bracket strap screws provided to tighten the wall mount bracket straps to the wall mount brackets.	
3	Ground disinfection chamber, as shown, to a suitable electrical ground. Check local electrical codes for proper location. (Grounding wire not included.) The disinfection chamber must be properly grounded prior to powering up the system. Attach the ground wire to the stud and nut located on the lower area of the disinfection chamber and connect it to the earth strap that is located at the bottom left of the electrical box. (Grounding wire included.)	

Mounting Electrical Control Box

The electrical control box can be mounted on the wall (Option A) or on the disinfection chamber (Option B), according to the following instructions.

Option A: Wall mount Follow these steps to mount the electrical control box on the wall.

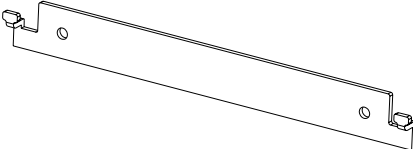
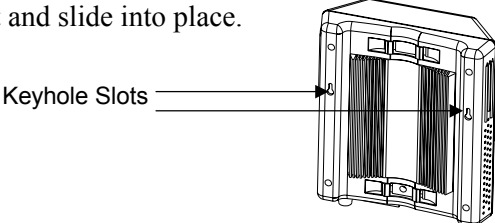
Step	Action
1	Attach the optional wall mount bracket to the wall using suitable hardware for your wall surface. 
2	Position the keyhole slots on the back of the electrical control box over the tabs on the wall mount bracket and slide into place. 

Option B: Chamber mount Follow these steps to mount the electrical control box on the disinfection chamber.

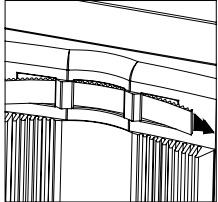
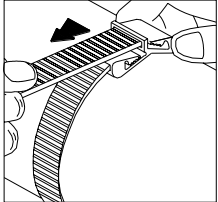
Step	Action	Diagram
1	Feed the electrical control box straps through the upper and lower recessed areas on the back of the electrical control box.	
2	Position the electrical control box on the UV disinfection chamber: Wrap the electrical box straps around the chamber, push loose end through high side of Q-Clip, and pull through to tighten.	

IMPORTANT! ! If it is necessary to remove the electrical control box strap, lift the pawl to release the Q-Clip. You may need to use a screwdriver to lift the pawl.

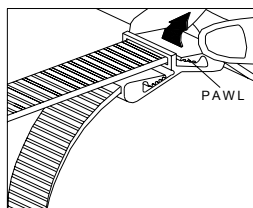

Installing the UV Lamp

CAUTION



UV lamp is very fragile. Do not handle it with bare hands. Use **clean cotton gloves or cloth** when handling lamp to keep it free of dust or fingerprints. If dust or fingerprints get on the lamp, wipe it with a clean cloth and alcohol.

Insert lamp in chamber

Follow these steps to install the UV lamp in the disinfection chamber.

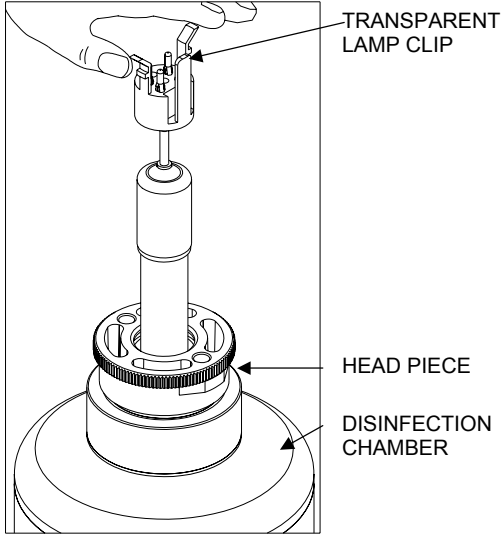
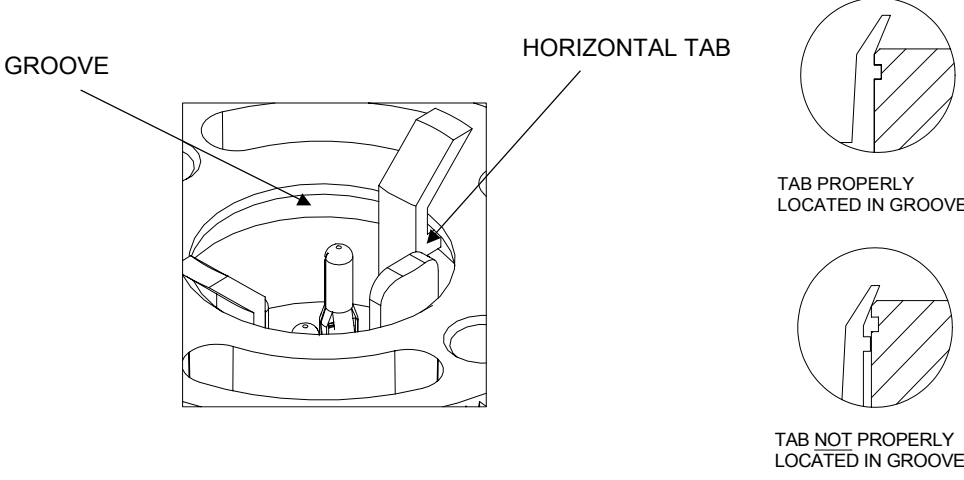
Step	Action
1	<p data-bbox="381 449 1372 520">Insert the lamp into the headpiece. Gently pinch the two large tabs on the transparent lamp clip and push until the tab locks into the groove (see step 2).</p> 
2	<p data-bbox="381 1094 1404 1165">Make sure that the transparent tab is properly snapped into the headpiece and is not pushed down too far.</p> 

Installing the UV Lamp, Continued

Position Glo-Cap

The Glo-Cap must be properly placed on the headpiece for the UV disinfection unit to work. Follow the steps below to position the Glo-Cap.

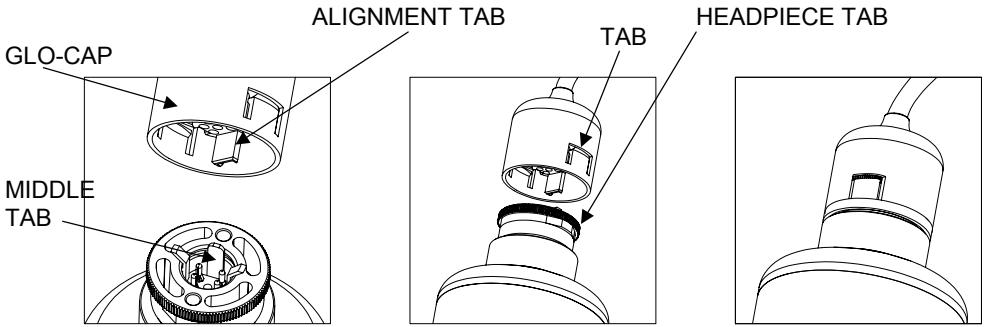
Step	Action
1	Align the tab on the Glo-Cap with the middle tab on the transparent clip.
2	<p>Lower the Glo-Cap onto the headpiece until it clicks into place. If it does not click into place, make sure that the tabs on the Glo-Cap are not over the raised tabs on the headpiece. If they are, turn the Glo-Cap. When properly installed, the Glo-Cap will not separate from the headpiece.</p> 

Pre-Start Up Sequence

Before using the unit...

Follow these steps before operating your WEDECO disinfection unit.

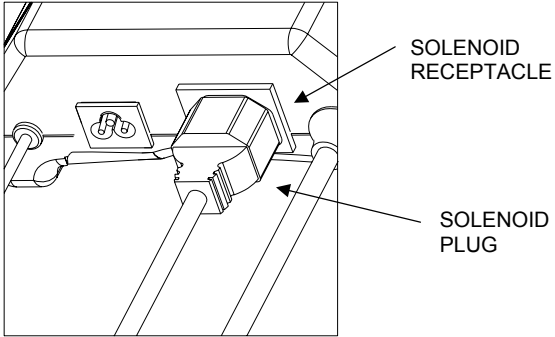
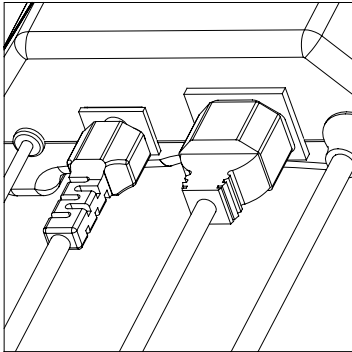
Step	Action
1	Check your plumbing: <ul style="list-style-type: none"> • Make sure that new plumbing has no leaks. • Flush pipes to purge soldering residue or other debris from the system. • Expel air from the system to avoid pressure damage to the unit.
2	Insert the solenoid valve plug into the solenoid valve receptacle located on the bottom of the electrical box. <div data-bbox="516 541 743 600" style="border: 1px solid black; padding: 5px; margin: 10px 0;"> <p style="text-align: center;">OPTIONAL</p> </div>  <p><i>Note: Solenoid is optional. WEDECO recommends installing the solenoid valve, which will shut off water supply in the event that certain alarms are triggered (see Alarms & Troubleshooting sections).</i></p>
3	Plug one end of power cord into receptacle on the bottom of electrical control box, making sure plug is pushed in completely. <p style="margin-left: 40px;"> ! IMPORTANT! Do not plug power cord into wall outlet until you begin the start-up sequence. </p> 

Start-Up Sequence

Before using the unit... Follow the start-up procedures below.

If your unit has...	Then...
No solenoid valve installed	<ul style="list-style-type: none">• Slowly fill the unit with water.• Plug power cord into wall outlet.• Within the first five seconds, press and hold the RESET button for 5 seconds to set internal "Days" counter to 365. The alarm buzzer will beep three times and all LEDs will blink three times to indicate that the unit has been reset.• Wait 30 seconds. If the lamp is working, the "Lamp On" LED will light and the internal "Days" counter will begin counting down.• Turn off water flow.• Sanitize your system before using your household water (see maintenance section for instructions. Slowly fill the unit with water.
Optional solenoid valve installed	<p>With the optional solenoid valve installed, a temporary water flow path must be provided for the first five minutes.</p> <ul style="list-style-type: none">• Slowly fill the unit with water.• Plug power cord into wall outlet.• Within the first five seconds, press and hold the RESET button for 5 seconds to set internal "Days" counter to 365. The alarm buzzer will beep three times and all LEDs will blink three times to indicate that the unit has been reset.• Wait 30 seconds. If the lamp is working, the "Lamp On" LED will light and the internal "Days" counter will begin counting down.• Turn off water flow.• Sanitize your water system before using the disinfection unit (see maintenance section for instructions).

Maintenance

Required maintenance

Periodically, you will need to perform routine maintenance procedures on your WEDECO UV disinfection unit. This section provides directions for:

- Replacing the lamp (every 365 days or in the event of a lamp-out alarm).
- Cleaning the quartz sleeve (as needed).
- Replacing the headpiece O-ring (every 365 days or when needed, based on visual inspection).

Replacing the lamp

The UV lamp is rated to provide 365 days of continuous use. After this time, it must be replaced for the disinfection unit to operate effectively.

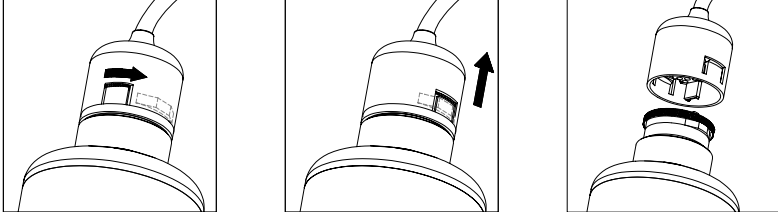
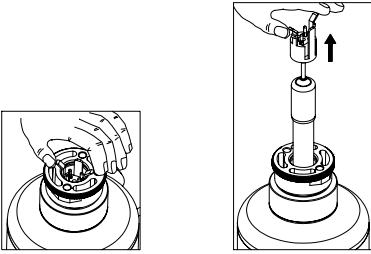
Step	Action
1	Turn off the water supply to the UV disinfection unit.
2	Disconnect all power to the UV disinfection unit and wait several minutes for the lamp to cool.
3	Drain the system: Have a bucket large enough to hold the water in the chamber, close both shutoff valves, and open the drain to draw off the water.
4	<p>Remove the Glo-Cap: Rotate the Glo-Cap so that the tabs line up with the raised tabs on the headpiece and pull the cap away from the headpiece to remove it.</p> <div style="text-align: center;">  </div>
5	<p>Remove the lamp: Gently pinch together the two large tabs on the transparent clip and pull lamp assembly straight up until it is completely removed.</p> <div style="text-align: center;">  </div> <p>! IMPORTANT! Lamp must be disposed of properly. Check your local regulations for disposal of hazardous materials.</p>
6	Insert the new UV lamp (refer to directions for installing the UV lamp).
7	Restart your disinfection unit according to the start-up sequence for your model specifications.
8	Record the date in the maintenance log.
9	Sanitize your water system (see directions in this section).

Maintenance, Continued

Cleaning the quartz sleeve, headpiece, & O-Ring

The quartz sleeve must be kept clean to kill bacteria effectively. Your water quality and mineral content will determine cleaning frequency. Perform a visual inspection after thirty (30) days of operation. If the sleeve is dirty, shorten cleaning intervals. If the sleeve is clean, lengthen cleaning intervals. At this time, clean the headpiece and O-Ring also.

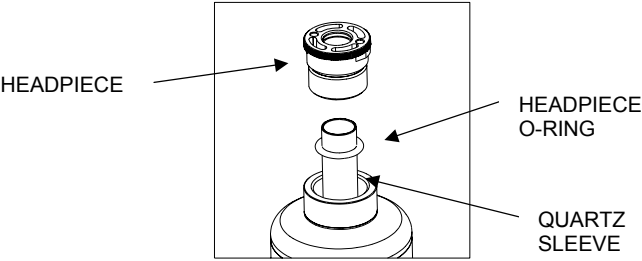
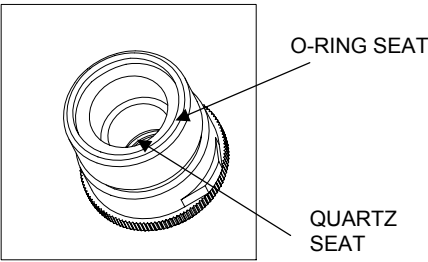
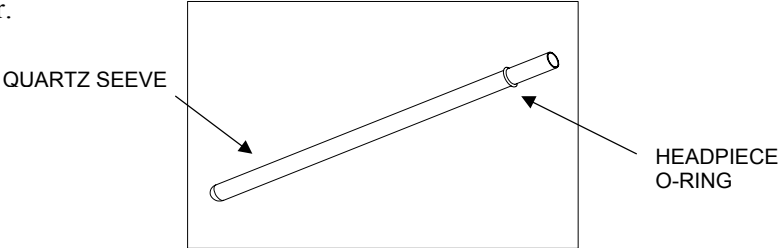
Step	Action
1	Fill bucket or other receptacle with warm, soapy water.
2	Follow Steps 1 through 5 for replacing the lamp (see previous page).
3	<p>Unscrew the headpiece and carefully remove the quartz sleeve from the disinfection chamber. IMPORTANT! The quartz sleeve may stick to the headpiece. Be sure to hold both pieces carefully so they don't separate during removal.</p>  <p>The diagram shows a cross-section of the disinfection chamber. A headpiece is being unscrewed from the top. Below it is a headpiece O-ring. The quartz sleeve is shown being pulled out from the chamber. Labels with arrows point to the HEADPIECE, HEADPIECE O-RING, and QUARTZ SLEEVE.</p>
3	<p>Take the headpiece and O-ring off the quartz sleeve. Clean the headpiece, O-Ring, and quartz sleeve with a mild soap and hot water solution. If the sleeve is still not clean, use a mild acid (citric acid or Lime-Away), then rinse with hot water.</p>  <p>The diagram shows a close-up of the quartz sleeve. It has two seats: an O-RING SEAT and a QUARTZ SEAT. Labels with arrows point to these two seats.</p>
4	<p>Push the O-Ring a few inches down on the quartz sleeve and lower the sleeve into the chamber.</p>  <p>The diagram shows the quartz sleeve and headpiece O-ring being pushed down into the chamber. Labels with arrows point to the QUARTZ SLEEVE and HEADPIECE O-RING.</p>
5	Screw the headpiece onto the disinfection chamber to secure the quartz sleeve and O-Ring in place.
6	Carefully reinstall the UV lamp and the Glo-Cap (see directions for installing the UV lamp).
7	Restart your disinfection unit according to the start-up sequence for your model specifications.
8	Record the date in the maintenance log.
9	Sanitize your water system (see directions in this section).

Maintenance, Continued

Replacing the O-Ring

General maintenance for the O-Ring requires that you replace it every 365 days. If, however, during routine cleaning of the quartz sleeve, you find the O-Ring cut, damaged, or extremely dirty, then it should be replaced at this time. To replace the O-Ring, follow the directions for cleaning.

Sanitizing the system

Before initial use of your UV unit and after routine maintenance procedures, you should sanitize your water system to ensure that no organisms are present.

Step	Action
1	Pour household bleach into your water system. If you have a filter container, fill it with bleach. If you have no filters then introduce chlorine directly into your well. The amount of chlorine depends upon the diameter and depth of your well. (Generally, use ½ gallon to treat an 8" diameter/80' deep well and one gallon for anything larger.) You may contact your State Extension Service or a water treatment specialist for additional information.
2	Open hot and cold water taps throughout the house and let the water run until you detect a chlorine odor. To ensure that the hot water heater is also purged, allow the hot water to run until the water becomes cold.
3	Turn off the taps and allow the water to stay in the pipeline for about six hours or overnight but not more than 36 hours to avoid corrosion.
4	Open hot and cold water taps throughout the house and let the water run until the chlorine odor disappears.

Maintenance Log

Note You must perform routine maintenance in order to achieve optimum performance levels from your WEDECO UV disinfection unit. As you perform routine maintenance or necessary service on your unit, record the dates in the maintenance log. The maintenance section of the Owner's Manual provides instructions for servicing and maintenance procedures.

Replace lamp (every 365 days)	Replace O-Ring (every 365 days)	Clean quartz sleeve (as needed)	Reset lamp counter (with lamp change)

Parts List

KEY #	PART #	QTY.	DESCRIPTION
1	*	1	Electrical Control Box
2	*	1	Disinfection Chamber
3	*	1	Quartz Sleeve
4	*	1	Ultraviolet Lamp
5	AQ35492	1	Head Piece O-Ring
6	AQ36538	1	Head Piece
7	AQ36617	1	Glo-Cap O-Ring
8	AQ36799	1	Glo-Cap
9	AQ702576	1	Sensor Assembly (not available on DLR-AP model)
10	AQ36942	2	Electrical Control Box Strap
10A	AQ36992	2	Electrical Control Box Strap Buckle
11	*	2	Wall Mount Bracket
12	*	2	Wall Mount Bracket Strap
13	*	4	Wall Mount Bracket Strap Screw
14**	*	1	Flow Control
15**	*	1	Solenoid Valve (OPTIONAL)
16**	AQ36944	1	Power Cord

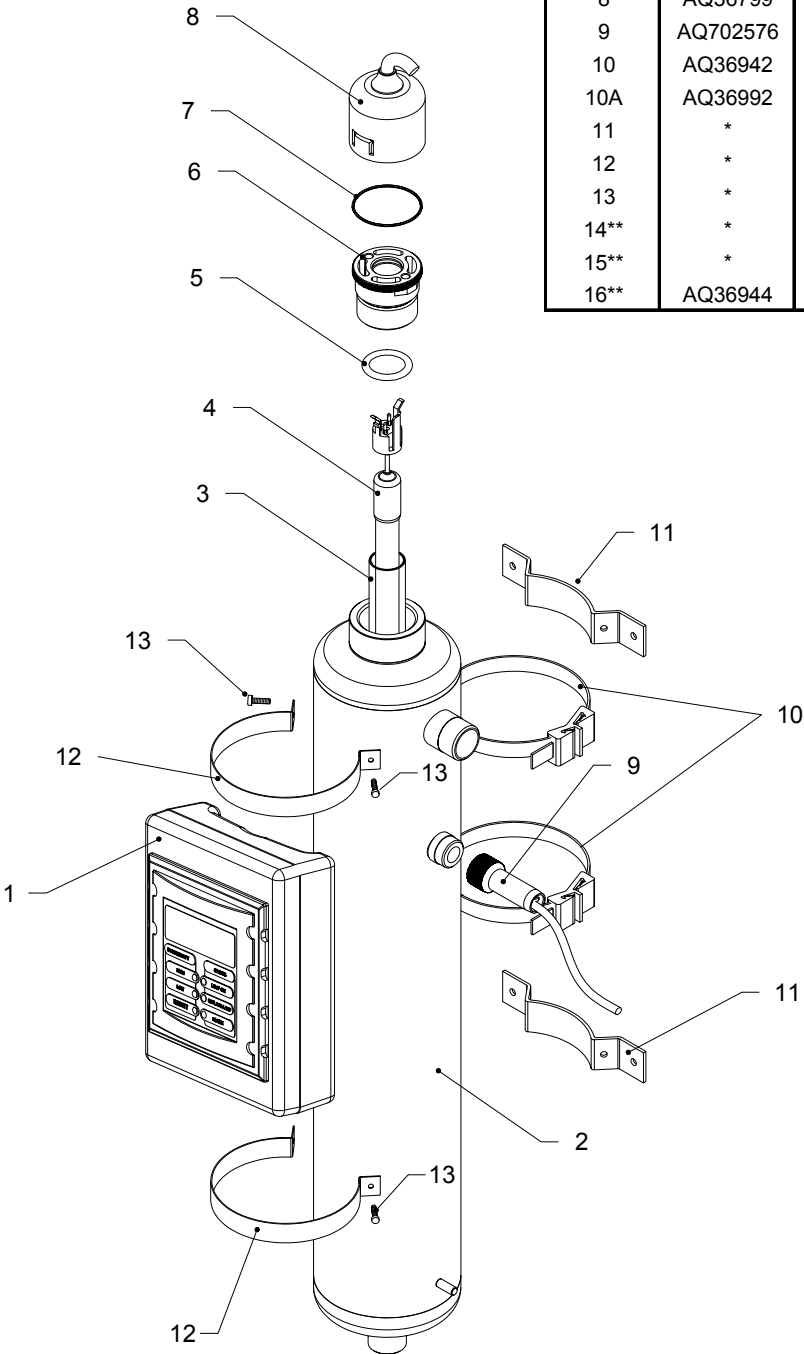

Contact the distributor for replacement parts

* Determined by serial number

** Not shown

Alarms

Displays

The front panel of the electrical control box has the following LED displays:

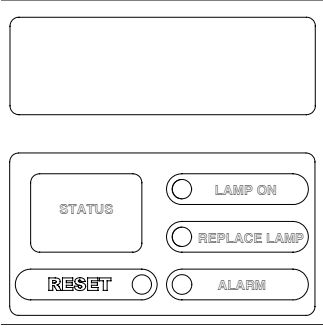
LED Displays	Diagram
<ul style="list-style-type: none"> • LAMP ON: green • REPLACE LAMP: red • ALARM: red 	

Alarm activation

The WEDECO UV disinfection unit has built in alarms to warn of inefficient performance or lamp failure.

Model	What Happens	Cause	How to Resolve
DLR-AP	<ul style="list-style-type: none"> • The REPLACE LAMP LED blinks. • The internal ALARM beeps once every 5 minutes. 	<p>The internal counter has reached 30 days of lamp life remaining.</p> <p>! IMPORTANT! Water to the house is being disinfected and the solenoid valve will remain open.</p>	<ul style="list-style-type: none"> • Press the RESET button once to silence the alarm buzzer for 5 days. The alarm buzzer will begin to beep again 5 days after pressing the RESET button and continue until lamp has been replaced and the unit reset. • Replace UV lamp within 30 days to ensure optimum performance from the unit.
DLR-AP	<ul style="list-style-type: none"> • The LAMP ON LED is no longer illuminated. • The REPLACE LAMP LED is illuminated continuously. • The ALARM LED blinks • The internal ALARM buzzer beeps continuously. 	<p>The internal counter has reached 0 (zero) days of lamp life. Or, lamp has failed due to another problem. (See Troubleshooting section.)</p> <p>! WARNING! Disinfection may be insufficient to ensure safe drinking water.</p>	<ul style="list-style-type: none"> • Press the RESET button once to silence the alarm buzzer for 5 days. The alarm buzzer will begin to beep again 5 days after pressing the RESET button and continue until lamp has been replaced and the unit reset. • Replace lamp immediately. Follow instructions on lamp replacement in the manual.

Troubleshooting

Determining problem The troubleshooting guide gives you suggestions for resolving problems.

If...	Then...
The unit is leaking water	<ul style="list-style-type: none"> • Ensure that the headpiece is tight. • Verify that inlet water pressure is not >125 psi. • Ensure that headpiece O-ring is seated properly. • Lubricate O-ring (use food-grade silicone). • Check O-ring for cracks or rips. Replace if necessary. • Check quartz sleeve for possible cracks. If sleeve is cracked, call distributor for replacement.
Glo-Cap is not lit or has gone out	<ul style="list-style-type: none"> • Verify that all electrical connections are correct. • Replace lamp. If problem is solved, resume unit operation. • If lamp still does not light, electrical control box may need to be replaced. Call distributor for replacement information.
Poor bacterial performance	<ul style="list-style-type: none"> • Replace lamp if it is more than 365 days old or nearing the end of its lamp life. • Perform routine maintenance. • Check water quality. If water quality has changed then you may need to install filters or other disinfection units to ensure that water supply does not exceed recommended maximum concentration levels (shown in Step 1 of Pre-Installation Instructions). • Verify flow rate using the flow rate table found in the Technical Specifications at the back of the manual.
Power fails	<ul style="list-style-type: none"> • The unit will restart automatically and the internal Days counter will be the same as before the power failure. If the unit has an optional solenoid valve installed, the valve will open 5 minutes after power is restored to the unit. • Upon restart if unit stays in alarm disconnect the power for 30 seconds. Restart the unit by pressing the reset button within 5 seconds. <p>Note: The unit is designed for continuous operation. Never connect the unit to a timer or other device, which will cause the unit to cycle on and off. Excessive cycling of the power will reduce lamp life.</p>
Display screen is blank	<ul style="list-style-type: none"> • Ensure that the unit is assembled and installed correctly. In the case of improper handling or assembly during installation and/or servicing, the unit will turn off power to the lamp and display a blank screen. • Check for damage to the lamp filament elements, quartz sleeve, or electrode connectors. Applying power to a unit with such damage will cause a blank display screen. Damage may be caused from shipping, overheating the lamp by operating the unit with no water in the chamber, introducing debris into the unit from the water source, or improper handling or assembly during service or installation. <p>Note: Units with the optional solenoid valve installed will turn off. In most cases, replacing the lamp, and/or quartz sleeve will return the unit to proper operation. If the unit fails to resume operation, notify your distributor.</p>
Unit gives faulty alarms	<ul style="list-style-type: none"> • The ballast or control circuit may be faulty. Call distributor for replacement information.
You miss the 5 second window for resetting unit	<ul style="list-style-type: none"> • If you miss the 5 seconds allotted to reset the unit, it may not calibrate properly. Disconnect the power for 30 seconds. Then supply power and restart the unit by pressing the RESET button within 5 seconds.

Technical Specifications: DLR Series

All prices and specifications are subject to change without notice.

Technical Description	
Description	The DLR Series is designed with a single low-pressure high-intensity UV lamp centered inside a protective quartz sleeve. The disinfection chamber is either 304 or 316L stainless steel and is electro-polished with male NPT Inlet/Outlet. The UV lamp and quartz jacket assembly are easily removable from one side of the disinfection chamber.
UV disinfection chamber	<ul style="list-style-type: none"> Material: stainless steel electro-polished UV sensor Mounting: vertical or horizontal Inlet/Outlet connections: Male NPT thread Mounting brackets included
UV lamp	High output low pressure UV lamp
Control Box	<ul style="list-style-type: none"> Material: ABS, designed for wall or UV chamber mounting Electronic power supply (ballast) LED readout Solenoid valve activator outlet Cable length UV chamber/control box: 4.9'
Application	The DLR series is engineered to disinfect clear fresh water to meet drinking water standards.
Operational capacity	Clear fresh water up to 30 US GPM
Options	<ul style="list-style-type: none"> Voltages 120 Volt /60 Hz (CE conforming) Solenoid inlet valve (NPT size corresponding to reactor NPT connection for each unit) 3/4", 1", and 1 1/2" normally closed.

Flow Rate Table: Valid for water with minimum UV transmittance $\geq 90\%$ @ 1cm (254nm)

DLR Series type	1	2	4	7
Flow rate (gpm) at UV dose of 40 mJ/cm ² at the end of lamp lifetime*	4	10	18	30
Flow rate (gpm) at UV dose of 30 mJ/cm ² at the end of lamp lifetime**	5	13	24	40

* 40 mJ/cm² = 40,000 μ Ws/cm²
 ** 30 mJ/cm² = 30,000 μ Ws/cm²

Notes: (1) Flow rates subject to final bioassay results
 (2) Flow rate for UV Dose 30 calculated based on NSF certified flow at 40 mJ/cm²
 (3) Flow rates based on flow restrictor installed in line.

UV Reactor, Stainless Steel 304 (1.4301) Electro-polished

Reactor connections, male NPT thread	1/2"	3/4"	3/4"	1"
Width (inches)	3.54	3.54	5	5
Height (inches)	18.5	26.38	26.38	40.55
Diameter (inches)	2.76	2.76	4.02	4.02
Weight (lb.) approx.	3.75	5.29	7.06	11.03
Operating pressure (psi) max.	125	125	125	125
Pressure loss (psi) approx.	2	2	2	2

UV Lamp, Low Pressure High Output

Lamp Type	NLR1825 WS	NLR1845 WS	NLR1845 WS	NLR1880 WS
Lamp Power (Watt)	16.5	40	40	84
UV-C Output at 254 nm, new lamp (Watt)	5.5	14	14	25
Quantity	1	1	1	1
Lamp lifetime (days)	365	365	365	365

Technical Specifications: DLR Series, Continued

Control Box				
DLR type	1	2	4	7
Width (inches) approx.	6.61	6.61	6.61	6.61
Height (inches) approx.	7.87	7.87	7.87	7.87
Depth (inches) approx.	2.6	2.6	2.6	2.6
Weight (lb) approx.	5.51	5.51	5.51	5.51
Voltage (V/Hz)	120V/60Hz	120V/60Hz	120V/60Hz	120V/60Hz
Cable length chamber/cabinet (ft)	4.9	4.9	4.9	4.9
Ambient temperature (°F)	95	95	95	95
Power consumption (W)	35	55	55	95

The DLR-AP is available in different sizes based on flow capacity. The varying technical features of the model are described below.

Model Characteristics	
Features	DLR-AP
Effective microbiological protection	●
Electro-polished stainless steel disinfection chamber	●
High output low pressure UV lamp	●
High efficiency electronic ballast power supply	●
Lamp operation indicator	●
Safety lamp connector (no lamp removal without lamp shut-off)	●
Micro-computer control	●
Audible alarm plus visual alarm display (lamp failure and end of lamp life)	●
Lamp change reminder with internal counter	●
Alarm and computer reset button	●
Selective UV monitoring system	
LED UV intensity display: high-low alarm (with separate UV intensity audible alarm)	
Power connection for optional automatic solenoid safety shut-off valve	●

Manufactured by:
 WEDECO Ideal Horizons, Inc.
 3520 Westinghouse Blvd.
 Charlotte, NC 28273
 Tel: (704) 716-7600
 Fax (704) 716-7601
www.wedecouv.com

Warranty

Note Save sales slip or cancelled check for proof of original purchase date to establish warranty period.

FULL ONE-YEAR WARRANTY ON UV DISINFECTION UNIT: For one (1) year from date of purchase, when this UV water disinfection unit is installed and maintained in accordance with our instructions, WEDECO will repair, free of charge, defects in material or workmanship in this UV water disinfection unit.

FULL TEN-YEAR WARRANTY ON DISINFECTION CHAMBER: For ten (10) years from date of purchase, WEDECO will furnish a new current model pressure vessel, free of charge, if the pressure vessel fails because of a manufacturing defect.

FULL TWO-YEAR WARRANTY ON ELECTRICAL PARTS: For two (2) years from date of purchase, WEDECO will provide, free of charge, parts and factory labor to repair or replace electrical parts that fail because of defects in material or workmanship.

FULL ONE-YEAR WARRANTY ON ULTRAVIOLET LAMP: For one (1) years from date of purchase, WEDECO will provide, free of charge, an ultraviolet lamp to replace a lamp that fails because of defects in materials or workmanship. This does not include lamps that are broken by the consumer.

FULL ONE-YEAR WARRANTY ON EXPENDABLE ITEMS: For one (1) year from date of purchase, WEDECO will provide, free of charge, expendable items such as quartz, viewport assemblies, gaskets, flow controls, and O-rings that fail because of defects in materials or workmanship.

WEDECO ULTRAVIOLET DISINFECTION UNIT WARRANTY

This warranty is void if equipment is not installed and operated according to instructions in the Owner's Manual. It does not apply to damage caused by abuse, accident, neglect, freezing, fire, floods, or acts of God. This warranty is void on any part from which the original manufacturing date code decal has been removed or made illegible. This warranty requires the use of WEDECO Ideal Horizons authorized replacement parts. All models must be operated and maintained in accordance with the Owner's Manual.

This warranty shall be void if the ultraviolet system is moved from the original point of installation, if the operating pressure exceeds 125 psi, or if the influent water temperature exceeds 100°F or goes below freezing.

All defective parts must be returned to WEDECO Ideal Horizons, Inc., for inspection and repair or replacement. Contact the factory for a **Return Goods Authorization Number** prior to shipment. Defective parts must be sent prepaid freight. WEDECO Ideal Horizons will inspect, test, and determine cause of defective component parts. WEDECO Ideal Horizons will not be liable for any labor charges other than factory repairs. Incidental or consequential damages are not covered by this warranty. Warranty DOES NOT cover freight costs.

The customer must order replacement parts as a standard purchase until the defective part is returned to the factory and evaluated. The factory will determine the extent of warranty coverage and proper warranty credit to be applied.

This warranty gives you specific legal rights and you may have other rights that will vary from state to state. Some states do not allow limitations on implied warranties or exclusion of incidental or consequential damages.

All claims must be submitted in writing to your ultraviolet equipment supplier within thirty (30) days from the discovery of the defect. Your ultraviolet equipment supplier will correct defective parts and/or workmanship within sixty (60) days from the time of receiving this notice.

Warranty Forms must be filled out and sent back to WEDECO Ideal Horizons for this warranty to be valid. WEDECO Ideal Horizons, Inc will keep Warranty Forms on file.